

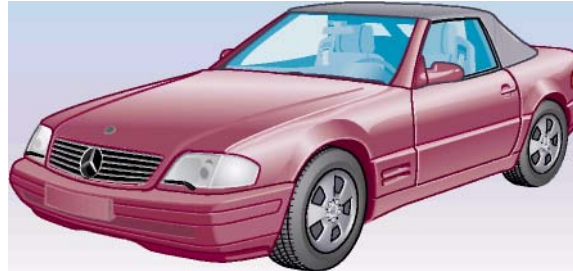

**Mercedes-Benz**



## **SL Operator's Manual**

**SL 320**  
**SL 500**  
**SL 600**

## Product information

Kindly observe the following in your own best interest:

We recommend using Mercedes-Benz original parts as well as conversion parts and accessories explicitly approved by us for your vehicle model. We have tested these parts to determine their reliability, safety and their special suitability for Mercedes-Benz vehicles.

We are unable to make an assessment for other products and therefore cannot be held responsible for them, even if in individual cases an official approval or authorization by governmental or other agencies should exist. Use of such parts and accessories could adversely affect the safety, performance or reliability of your vehicle. Please do not use them. Mercedes-Benz original parts as well as conversion parts and accessories approved by us are available at your authorized Mercedes-Benz Center where you will receive comprehensive information, also on permissible technical modifications, and where proper installation will be performed.

Our company and staff congratulate you on the purchase of your new Mercedes-Benz.

Your selection of our product is a demonstration of your trust in our company name. Further, it exemplifies your desire to own an automobile that will be as easy as possible to operate and provide years of service.

Your Mercedes-Benz represents the efforts of many skilled engineers and craftsmen. To ensure your pleasure of ownership, and for your safety and that of your passengers, we ask you to make a small investment of your time:

- Please read this manual carefully before putting it aside. Then return it to your vehicle where it will be handy for your reference.
- Please abide by the recommendations contained in this manual. They are designed to acquaint you with the operation of your Mercedes-Benz.
- Please abide by the warnings and cautions contained in this manual. They are designed to help improve the safety of the vehicle operator and occupants.

We extend our best wishes for many miles of safe, pleasurable driving.

DaimlerChrysler AG

## **Operator's manual**

This Operator's Manual contains a great deal of useful information. We urge you to read it carefully and familiarize yourself with the vehicle before driving.

For your own safety and longer service life of the vehicle, we urge you to follow the instructions and warnings contained in this manual. Ignoring them could result in damage to the vehicle or personal injury to you or others. Vehicle damage caused by failure to follow instructions is not covered by the Mercedes-Benz Limited Warranty.

Your vehicle may have some or all of the equipment described in this manual. Therefore, you may find explanations for optional equipment not installed in your vehicle. If you have any questions about the operation of any equipment, your authorized Mercedes-Benz Center will be glad to demonstrate the proper procedures.

### **Service and warranty information**

The Service and Warranty Information Booklet contains detailed information about the warranties covering your Mercedes-Benz, including:

- New Car Limited Warranty,
- Emission System Warranty,
- Emission Performance Warranty,
- California, Massachusetts, and Vermont Emission Control System Warranty (California, Massachusetts, and Vermont only),
- State Warranty Enforcement Laws (Lemon Laws).

## **Important notice for California retail buyers of Mercedes-Benz automobiles**

Under California law you may be entitled to a replacement of your vehicle or a refund of the purchase price, if Mercedes-Benz USA, LLC or its authorized Mercedes-Benz Center fails to conform the vehicle to its express warranties after a reasonable number of repair attempts during the period of one year or 12 000 miles from original delivery of the vehicle. A reasonable number of repair attempts is presumed for a retail buyer (1) if the vehicle is out of service by reason of repair of substantial nonconformities for a cumulative total of more than 30 calendar days or (2) the same substantial non-conformity has been subject to repair four or more times **and you have at least once directly notified us in writing of the need to repair the non-conformity and have given us an opportunity to perform the repair ourselves. Notifications should be sent to the nearest Mercedes-Benz Regional Office listed in the Service and Warranty Information Booklet.**

### **Maintenance**

The Service Booklet describes all the necessary maintenance work which should be performed at regular intervals. Always have the Service Booklet with you when you take the vehicle to your authorized Mercedes-Benz Center for service. The service advisor will record each service in the booklet for you.

### **Roadside assistance**

The Mercedes-Benz Roadside Assistance Program provides factory trained technical help in the event of a breakdown. Calls to the toll-free Roadside Assistance number:

**1-800-FOR-MERCEdes (in the USA)**

**1-800-387-0100 (in Canada)**

will be answered by Mercedes-Benz Client Assistance Representatives 24 hours a day, 365 days a year.

For additional information refer to the Mercedes-Benz Roadside Assistance Program brochure in your glove box.

## **Change of address or ownership**

If you change your address, be sure to send in the "Change of Address Notice" found in the Service and Warranty Information Booklet, or simply call the Mercedes-Benz Client Assistance Center (in the USA) at 1-800-FOR-MERCEdes, or Customer Service (in Canada) at 1-800-387-0100. It is in your own interest that we can contact you should the need arise.

If you sell your Mercedes, please leave all literature with the vehicle to make it available to the next operator.

If you bought this vehicle used, be sure to send in the "Notice of Purchase of Used Car" found in the Service and Warranty Information Booklet, or call the Mercedes-Benz Client Assistance Center (in the USA) at 1-800-FOR-MERCEdes, or Customer Service (in Canada) at 1-800-387-0100.

## **Operating your vehicle outside the USA or Canada**

If you plan to operate your vehicle in foreign countries, please be aware that:

- Service facilities or replacement parts may not be readily available,
- unleaded gasoline for vehicles with catalytic converters may not be available; the use of leaded fuels will damage the catalyts,
- gasoline may have a considerably lower octane rating, and improper fuel can cause engine damage.

Certain Mercedes-Benz models are available for delivery in Europe under our European Delivery Program.

For details, consult your authorized Mercedes-Benz Center or write to:

In the USA:

Mercedes-Benz USA,  
LLC European Delivery Department  
One Mercedes Drive  
Montvale, NJ 07645-0350

In Canada:

Mercedes-Benz Canada, Inc.  
European Delivery Department  
849 Eglinton Avenue East  
Toronto, Ontario M4G 2L5

We continuously strive to improve our product, and ask for your understanding that we reserve the right to make changes in design and equipment. Therefore, information, illustrations and descriptions in this Operator's Manual might differ from your vehicle. Optional equipment is also described in this manual, including operating instructions wherever necessary. Since they are special-order items, the descriptions and illustrations herein may vary slightly from the actual equipment of your vehicle.

If there are any equipment details that are not shown or described in this Operator's Manual, your authorized Mercedes-Benz Center will be glad to inform you of correct care and operating procedures.

The Operator's Manual and Service Booklet are important documents and should be kept with the vehicle.

## **Check Regularly and Before a Long Trip**

See Index

### **The First 1000 Miles (1500 km)**

The more cautiously you treat your vehicle during the break-in period, the more satisfied you will be with its performance later on. Therefore, drive your vehicle during the first 1000 miles (1500 km) at moderate vehicle and engine speeds.

During this period, avoid heavy loads (full throttle driving) and high RPM.

Avoid accelerating by kickdown. It is not recommended to brake the vehicle by manually shifting to a lower gear.

We recommend to select positions "3", "2" or "B" (for models SL 500 and SL 600) only at moderate speeds (for hill driving). After 1000 miles (1500 km) speeds may be gradually increased to the permissible maximum.

### **Maintenance**

We strongly recommend that you have your vehicle serviced by your authorized Mercedes-Benz dealer, in accordance with the Maintenance Booklet.

Failure to have the vehicle maintained in accordance with the Maintenance Booklet may result in vehicle damage not covered by the Mercedes-Benz Limited Warranty.

## Introduction

<a href="#">Product information</a>	2
<a href="#">Operator's manual</a>	4
<a href="#">Consumer Information</a>	141
<a href="#">Problems with your vehicle</a>	142
<a href="#">Reporting Safety Defects</a>	143
<a href="#">Index</a>	146

## Instruments and controls

<a href="#">Instruments and controls</a>	10
<a href="#">Instrument Cluster</a>	12
<a href="#">Indicator Lamp Symbols</a>	13
<a href="#">Catalytic Converter</a>	14
<a href="#">Starting and Turning Off the Engine</a>	15
<a href="#">Driving Instructions</a>	16

## Operation

<a href="#">Automatic Climate Control</a>	22
<a href="#">Car Keys</a>	26
<a href="#">Infrared Remote Control</a>	27
<a href="#">Interior central locking system</a>	32
<a href="#">Interior Central Locking System</a>	32
<a href="#">Anti-Theft Alarm System</a>	33
<a href="#">Power seats</a>	34
<a href="#">Orthopedic seat Backrest</a>	37

<a href="#">Heated Seats</a>	38	<a href="#">Soft top</a>	67
<a href="#">Armrest</a>	39	<a href="#">Wind Screen</a>	70
<a href="#">Adjusting steering column</a>	39	<a href="#">Antenna</a>	72
<a href="#">Seat belts</a>	40	<a href="#">Cellular Telephone</a>	72
<a href="#">Seat belts and Supplemental restraint system (SRS)</a>	40	<b>Driving</b>	
<a href="#">Emergency tensioning retractor (ETR)</a>	44	<a href="#">Drinking and Driving</a>	74
<a href="#">Airbags</a>	45	<a href="#">Parking Brake</a>	74
<a href="#">Steering Lock</a>	50	<a href="#">Driving off</a>	74
<a href="#">Exterior Lamp Switch</a>	51	<a href="#">Engine Oil Pressure Gauge</a>	74
<a href="#">Combination Switch</a>	52	<a href="#">Tachometer</a>	74
<a href="#">Exterior rear view mirror</a>	54	<a href="#">Automatic Transmission</a>	75
<a href="#">Inside rear view mirror</a>	55	<a href="#">Cruise Control</a>	80
<a href="#">Instrument Lamps</a>	55	<a href="#">Charge Indicator Lamp with oil pressure warning lamp</a>	82
<a href="#">Display Illumination</a>	55	<a href="#">Engine oil pressure Gauge with oil pressure warning lamp</a>	83
<a href="#">Trip odometer</a>	55	<a href="#">Low Engine Oil Level Warning Lamp</a>	83
<a href="#">Sun Visors</a>	56	<a href="#">Engine Oil Consumption</a>	83
<a href="#">Setting clock</a>	56	<a href="#">Fuel Consumption Gauge</a>	83
<a href="#">Console storage compartments</a>	57	<a href="#">Fuel Reserve Warning Lamps</a>	84
<a href="#">Storage Compartments (Eyeglasses compartment) in dashboard</a>	57	<a href="#">Outside Temperature Indicator</a>	84
<a href="#">Door pockets</a>	58	<a href="#">Coolant Temperature Gauge</a>	84
<a href="#">Lighter</a>	58	<a href="#">Low Engine Coolant Level Warning Lamp</a>	85
<a href="#">Interior Lighting</a>	59	<a href="#">Low windshield &amp; headlamp washer system fluid level warning lamp</a>	85
<a href="#">Power Windows</a>	61		
<a href="#">Roll Bar</a>	62		
<a href="#">Hardtop</a>	63		



<a href="#">Roll Bar Warning Lamp</a>	86	<a href="#">Spare Wheel</a>	100	<b>Technical Data. Fuels, Coolants,</b>	
<a href="#">Seat Belt and Backrest Lock Warning Lamp</a>	86	<a href="#">First Aid Kit</a>	100	<b>Lubricants etc. Consumer Info.</b>	
<a href="#">Exterior Lamp Failure Indicator Lamp</a>	86	<a href="#">Vehicle Jack</a>	101	<a href="#">Identification Plates</a>	128
<a href="#">Brake Pad Wear Indicator Lamp</a>	87	<a href="#">Vehicle Tools</a>	101	<a href="#">Vehicle Data Card</a>	129
<a href="#">Brake Warning Lamp</a>	87	<a href="#">Wheels</a>	101	<a href="#">Warranty Coverage</a>	129
<a href="#">ABS (Antilock Brake System) Warning Lamp</a>	88	<a href="#">Changing Wheels</a>	103	Technical Data 320 SL	130
<a href="#">Acceleration Slip Control (ASR)</a>	89	<a href="#">Tire inflation Pressure</a>	106	500 SL	132
<a href="#">Adaptive damping system (ADS)</a>	91	<a href="#">Battery</a>	107	<a href="#">600SL</a>	134
<a href="#">Emission Control</a>	92	<a href="#">Fuses</a>	107	<a href="#">Fuels, Coolants, Lubricants etc.</a>	136
<a href="#">On-Board Diagnostic System (California models only)</a>	92	<a href="#">Exterior lamps</a>	108	<a href="#">Capacities</a>	136
<a href="#">Traveling Abroad</a>	93	<a href="#">Jump Starting</a>	109	<a href="#">Engine Oils</a>	138
<a href="#">Winter Driving</a>	93	<a href="#">Towing the Vehicle</a>	111	<a href="#">Engine Oils additives</a>	148
<a href="#">Snow Chains</a>	93	<a href="#">Cleaning and Care of the Vehicle</a>	113	<a href="#">Air conditioner refrigerant</a>	138
		<a href="#">Testing Infrared Remote Control</a>	114	<a href="#">Brake Fluid</a>	138
		<a href="#">Locking softtop manually</a>	118	<a href="#">Premium Unleaded Gasoline</a>	139
			119	<a href="#">Fuel Requirements</a>	139
<b>Practical Hints</b>		<a href="#">Locking hardtop manually</a>	122	<a href="#">Gasoline Additives</a>	139
<a href="#">Hood</a>	96	<a href="#">Ashtray</a>	123	<a href="#">Coolants</a>	140
<a href="#">Checking Coolant Level</a>	97	<a href="#">Manual Release of Fuel Filler Flap</a>	123	<a href="#">Check regularly and before a long trip</a>	152
<a href="#">Adding Coolant</a>	97	<a href="#">Ski Rack</a>	123		
<a href="#">Checking engine oil level</a>	98	<a href="#">Replacing Wiper Blades</a>	124		
<a href="#">Checking Automatic Transmission Fluid Level</a>	99	<a href="#">Layout of Poly-V-Belt Drive</a>	125		
<a href="#">Trunk Lamp</a>	100	<a href="#">MERCEDES-BENZ Spare Parts Service</a>	125		

## Instruments and Controls

*For more detailed descriptions see Index.*

1	Adjustable air outlet		17	Air volume control for right air outlet
2	Exterior lamp switch		18	Automatic climate control
3	Parking brake release		19	Radio
4	Hood lock release		20	Rear window defroster switch
5	Parking brake pedal		21	Indicator lamp for Anti-theft alarm system
6	Combination switch		22	Hazard warning flasher switch
7	Cruise control		23	Adaptive damping system adjustment switch
8	Horn, airbag		24	Snow chain switch
9	Instrument cluster		25	Roll bar operation switch
10	Steering lock with ignition/starter switch		26	Compartment (to open press bottom of cover)
11	Adjustable air outlet		27	Mirror adjustment switch
12	Heated air supply button - center air outlet		28	Soft/hardtop operation switch
13	Non heated/cooled air supply button - center air outlet		29	Seat heater switch
14	Storage/eyeglasses compartment		30	Power window switch
15	Air volume control for left air outlet		31	Ashtray with lighter
16	Air volume control for center air outlet			

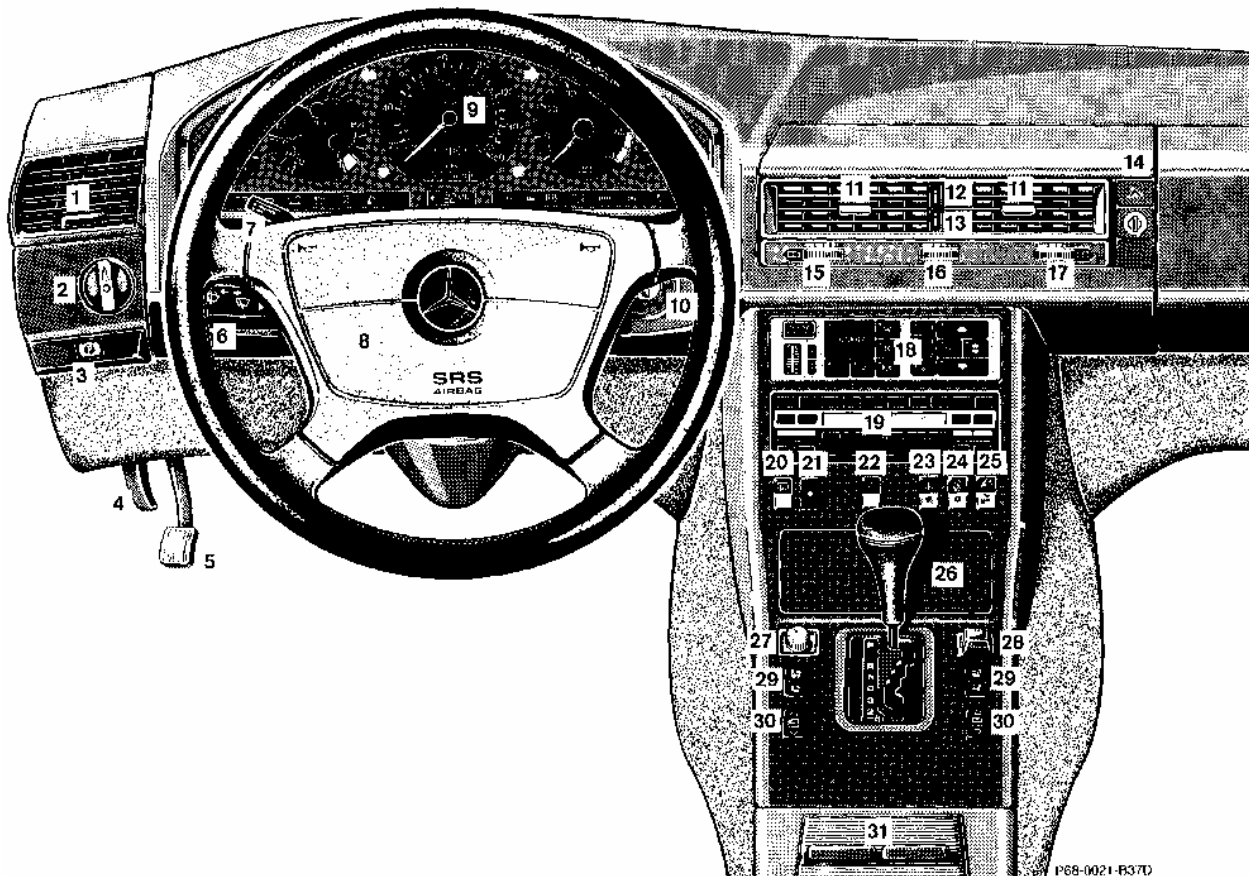

P68-0021-B37D

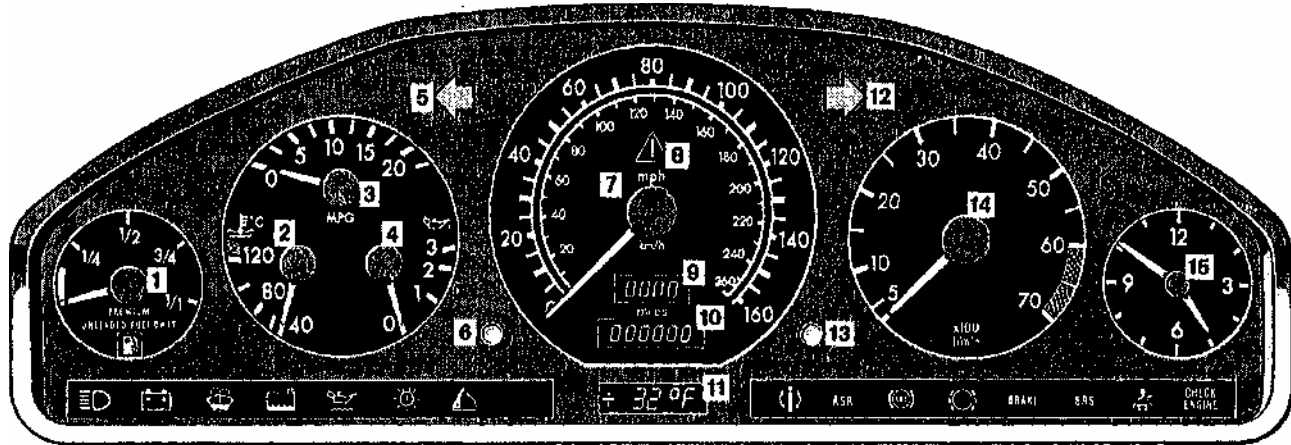

P54-0013-034D

## Instrument Cluster

- 1 Fuel gauge with reserve warning lamp (yellow). See Index.
- 2 Coolant temperature gauge. See Index.
- 3 Fuel consumption gauge. See Index.
- 4 Engine Oil pressure gauge (bar). See Index.
- 5 Left turn signal indicator lamp (green)
- 6 Knob for instrument lamps and trip odometer. See Index.
- 7 Speedometer
- 8 ASR function indicator lamp (yellow). See Index in Owner's Manual.
- 9 Trip odometer. See Index.
- 10 Main odometer
- 11 Outside temperature indicator. See Index.
- 12 Right turn signal indicator lamp (green)
- 13 Knob for setting clock. See Index.
- 14 Tachometer. See Index.
- 15 Clock See Index.

## Indicator Lamp Symbols Function Indicator Lamp



High beam

### Warning Lamp

(should go out with the engine running unless)



Battery not being charged properly. See Index.



Fluid level for windshield and headlamp washer system low. See Index.



Coolant level low. See Index.



Engine oil level low. See Index.



Exterior lamp failure. See Index.



Roll bar malfunction. See Index.



ADS malfunction. See Index.



ASR malfunction. See Index.



ADS malfunction. See Index.



ABS malfunction. See Index.



Brake pads worn down. See Index.



Brake fluid low (except Canada).  
Parking brake engaged. See Index.



Brake fluid low (Canada only).  
Parking brake engaged. See Index.



SRS malfunction. See Index.



Fasten seat belts. Backrest not locked.  
See Index.



Engine malfunction indicator lamp  
SL 500 (California only), SL 320, SL 600 (all).  
If the lamp comes on when the engine is running, it  
indicates a malfunction of the fuel injection system  
or emission control system. In either case, we  
recommend that you have the malfunction checked  
as soon as possible. See Index.

## Catalytic Converter

Your MERCEDES-BENZ is equipped with monolithic type catalytic converters, an important element in conjunction with the oxygen sensor to achieve substantial control of the pollutants in the exhaust emissions. Keep your vehicle in proper operating condition by following our recommended maintenance instructions as outlined in your Maintenance Booklet.

## Caution!

To prevent damage to the catalytic converters, use only premium unleaded gasoline in this vehicle.

Any noticeable irregularities in engine operation should be repaired promptly. Otherwise, excessive unburned fuel may reach the catalytic converter causing it to overheat.

## Warning!

**As with any vehicle, do not idle, park or operate this vehicle in areas where combustible materials such as grass, hay or leaves can come into contact with the hot exhaust system, as these materials could be ignited.**

## **Starting and Turning off the Engine**

### **Before Starting**

Engage parking brake and ensure gearshift lever is in neutral (selector lever position "P" or "N" on automatic transmissions).

Turn key in steering lock to position 2. The charge indicator lamp should come on.

### **Cold Engine**

Do not depress accelerator. Turn key in steering lock clock-wise to the stop. Do not depress accelerator. Release key only when the engine is firing regularly.

## **Hot Engine**

Do not depress accelerator. Turn key in steering lock clock-wise to the stop. If the engine has not fired after approx. 4 seconds, depress accelerator and continue cranking until the engine is firing regularly. Release key and back off accelerator.

At very high coolant temperatures the engine starting time can be shortened if the accelerator is depressed slowly at the beginning of the starting process.

### **Turning Off**

Turn the key in the steering lock to position 0 to stop the engine.

Note:

Vehicles with automatic transmission: the key can only be removed with the selector lever in position "P".

If the coolant temperature is very high (e.g. after hard driving on mountain roads), do not shut off the engine immediately, but allow it to run for 1-2 minutes at increased idle speed with selector lever in position "P" or "N".

## **Important!**

Due to the installed starter non-repeat feature, the key must be turned completely to the left before attempting to start the engine again.

Observe the oil pressure gauge immediately after starting the engine. In a very cold engine the oil pressure will rise slowly after the engine has started. Do not speed up the engine before pressure is registered on the pressure gauge. If you do not see the gauge register oil pressure, stop the engine and have it checked.

The battery charge indicator lamp should go out as soon as the engine has started.

In areas where temperatures frequently drop below -4°F (-20°C) we recommend that an engine block heater be installed. Your authorized Mercedes-Benz dealer will advise you on this subject.

## **Driving Instructions Power Assistance**

### **Warning!**

When the engine is not running, the brake and steering systems are without power assistance. Under these circumstances, a much greater effort is necessary to stop or steer the vehicle.

## **Brakes**

### **Caution!**

When driving down long and steep grades, relieve the load on the brakes by shifting into "3", "2" or "B" (for models SL 500 and SL 600). This helps prevent overheating of the brakes and reduces brake pad wear. Do not exceed engine speed limits. Refer to Technical Data for downshift points.

After hard braking, it is advisable to drive on for some time, rather than immediately parking, so the air stream will cool down the brakes faster.

### **Warning!**

After driving in heavy rain for some time without applying the brakes or through water deep enough to wet brake components, the first braking action may be somewhat reduced and increased pedal pressure may be necessary. Be sure to maintain a safe distance from vehicles in front.

The condition of the parking brake system is checked each time the car is in the shop for the required maintenance.

Between maintenance checks, it is a good practice to apply the parking brake once or twice while driving at approximately 30 mph (50 km/h) on a dry straight road. Apply parking brake lightly while pulling the release handle out until a slight drag on the wheels is felt. Keep applying the brake for about 10 seconds while pulling the release handle out before releasing the parking brake completely. This practice will keep the parking brake at maximum efficiency.

### **Warning!**

The stop lamps will not come on when applying the parking brake only. Perform the procedure in the previous paragraph only when the road is clear of other traffic.

Resting your foot on the brake pedal will cause excessive and premature wear of the brake pads.

**It can also result in the brakes overheating thereby significantly reducing their effectiveness. It may not be possible to stop the car in sufficient time to avoid an accident.**

All checks and maintenance work on the brake system should be carried out by an authorized Mercedes-Benz dealer.



If the parking brake is released and the brake warning lamp in the instrument cluster stays on, the brake fluid level in the reservoir is too low.

Brake pad wear or a leak in the system may be the reason for low brake fluid in the reservoir.

Have the brake system inspected at an authorized Mercedes-Benz dealer immediately.

Install only brake pads and brake fluid recommended by Mercedes-Benz.

### **Warning!**

**If other than recommended brake pads are installed, the braking properties of the vehicle can be affected to an extent that safe braking is substantially impaired.**

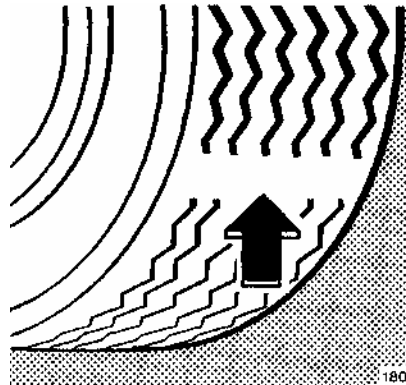

### **Tires**

Tread wear indicators (TWI) are required by law. These indicators are located in six places on the tread circumference and become visible at a depth of approximately  $\frac{1}{16}$  in (2 mm), at which point the tire is considered worn and should be replaced. The tread wear indicator appears as a solid band across the tread.

### **Warning!**

**Do not allow your tires to wear down too far. With less than  $\frac{1}{16}$  in (1.5 mm) of tread, the adhesion properties on a wet road are sharply reduced.**

**Depending upon the weather and/or road surface (conditions), the tire traction varies widely.**

Specified tire pressures must be maintained. This applies particularly if the tires are subjected to high loads (e.g. high speeds, heavy loads, high ambient temperatures).

### **Warning!**

**Do not drive with a flat tire. A flat tire affects the ability to steer or brake the vehicle. You may lose control of the car. Continued driving with a flat tire or driving at high speed with a flat tire will cause excessive heat build-up and possibly a fire.**

## **Aquaplaning**

Depending on the depth of the water layer on the road, aquaplaning may occur, even at low speeds and with new tires. Avoid track grooves in the road and apply brakes cautiously in the rain.

## **Tire Traction**

The safe speed on a wet, snow covered or icy road is always lower than on a dry road.

You should pay particular attention to the condition of the road as soon as the prevailing temperatures fall close to the freezing point.

## **Warning!**

**If ice has formed on the road, tire traction will be substantially reduced. Under such weather conditions, drive, steer and brake with extreme caution.**

We recommend M + S radial-ply tires for the winter season for all four wheels to insure normal balanced handling characteristics.

On packed snow, they can reduce your stopping distance as compared with summer tires. Stopping distance, however, is still considerably greater than when the road is wet or dry.

## **Parking**

### **Warning!**

**To reduce the risk of personal injury as a result of vehicle movement, before turning off the engine and leaving the vehicle always:**

- 1. Keep foot on brake pedal.**
- 2. Firmly depress parking brake pedal.**
- 3. Engage first or reverse gear (selector lever position “P” in the case of automatic transmissions).**
- 4. Slowly release brake pedal.**
- 5. Turn front wheels towards the road curb.**
- 6. Turn the key to steering lock position 0 and remove.**

### **Important!**

It is advisable to set the parking brake whenever parking or leaving the vehicle. In addition, engage first or reverse gear (selector lever position “P”).

When parking on hills, always set the parking brake.

## Winter Driving Instructions

The most important rule for slippery or icy roads is to drive sensibly and to avoid abrupt acceleration, braking and steering action. Do not use the cruise control system under such conditions.

When the vehicle is in danger of skidding, declutch, or in case of automatic transmission move selector lever to position “N”. Try to keep the vehicle under control by corrective steering action.

Road salts and chemicals can adversely affect braking efficiency. Increased pedal force may become necessary to produce the normal brake effect. We therefore recommend depressing the brake pedal periodically when traveling at length on salt-strewn roads. This can bring road salt impaired braking efficiency back to normal. A prerequisite is, however, that this is done without endangering other drivers on the road.

If the vehicle is parked after being driven on salt treated roads, the braking efficiency should be tested as soon as possible after driving is resumed while observing the safety rules in the previous paragraph.

### Warning!

**If the vehicle becomes stuck in snow, make sure that snow is kept clear of the exhaust pipe and from around the vehicle with engine running. Otherwise, deadly carbon monoxide (CO) gases may enter vehicle interior resulting in unconsciousness and death.**

**To assure sufficient fresh air ventilation, open a window slightly on the side of the car that is out of the wind.**

## Passenger Compartment

### Warning!

**Always fasten items being carried as securely as possible. In an accident, during hard braking or sudden maneuvers, loose items will be thrown around inside the vehicle, and cause injury to vehicle occupants unless the items are securely fastened in the vehicle.**

**Operation**

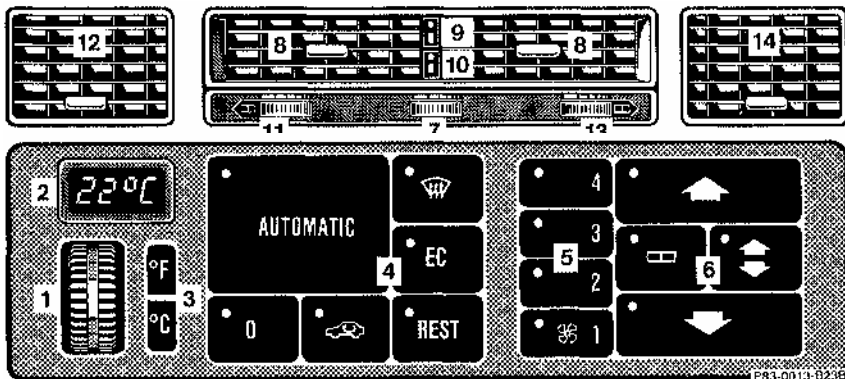

7. Air volume control for center air outlet, turn left to open
8. Center air outlet, adjustable
9. Heated air supply button center air outlet (red indicator lamp)
10. Non-heated/cooled air supply button for center air outlet (blue indicator lamp)
11. Air volume control for left air outlet, turn left to open
12. Left air outlet, adjustable
13. Air volume control for right air outlet, turn left to open
14. Right air outlet, adjustable

### Automatic Climate Control

1. Temperature selector
2. Temperature indicator
3. Conversion switch
4. Function selection buttons

	Normal setting
	Defrost
	Economy ( no cooling )
	Residual engine heat utilization
	Air recirculation
	Off

5. Fan speed buttons, 4 stages
6. Air distribution buttons



Air is directed to windshield

Air is directed to windshield, foot area and doors

Air is directed to foot area and doors

Air is directed only to air outlets 8, 12 and 14 (open outlets)

Notes:

The temperature selected with the temperature selector is reached as quickly as possible.

The temperature selector should be left at the desired temperature setting.

With the center air outlet (8) open and the system in heating mode, switch outlet to warm air by pressing button 9 (red indicator lamp lights up), or to non-heated/cooled air by pressing button 10 (blue indicator lamp lights up).

The system will not heat or cool any quicker by setting a higher or lower temperature.

The automatic climate control only operates with the engine running. Higher engine rpm results in higher coolant compressor rpm, thereby increasing cooling capacity.

The automatic climate control removes considerable moisture from the air during operation in the cooling mode. It is normal for water to drip on the ground through ducts in the underbody. Outside air is drawn in through a filter. Dust particles (up to a certain size) and pollen are filtered out.

### **Important!**

This vehicle is equipped with an air conditioner system that uses HFC-134a (ozone-friendly hydro-fluorocarbon) as a refrigerant.

Repairs should always be performed by a qualified technician, and refrigerant should be collected in a recovery system for recycling.

## **1 Temperature Selector**

Select the desired temperature with the temperature selector.

A basic setting in the white field of the selector is recommended.

The selected temperature is shown in the indicator window 2. With conversion switch 3, the selected temperature can be displayed in either °F or °C.

#### 4. Function Selection Buttons





##### Normal Setting

Air volume and distribution are controlled automatically.

To select:

Press  button (indicator lamp lights up)

To change selection:

- Press ,  or  button (indicator lamp of selected button lights up). The indicator lamp for  button goes out.
- Press button 6 (indicator lamp lights up). The indicator lamp for  button goes out.

##### Defrost

Maximum heated and automatically controlled amount of air is directed to the windshield and side windows. As the engine coolant temperature increases, a higher blower stage is automatically engaged, thereby defrosting as quickly as possible.

Turn air volume controls 11 and 13 left to open air outlets 12 and 14. Direct airlets towards the side windows. The center air outlets and the foot area ducts are closed.

To select:

Press  button (indicator lamp lights up).

##### Defogging Windows

Switch on  .

Switch off  .

##### Economy

The function of this setting corresponds to the normal setting. However, because the air conditioning compressor will not engage (fuel savings), it is not possible to air condition in this setting.

## Residual Engine Heat

### Utilization

With the engine switched off, it is possible to continue heating the interior for a short while.

Air volume and distribution are controlled automatically.

To select:

Turn key in steering lock to position 1 or 0 or remove key.

Press  button (indicator lamp lights up). This function selection will not activate if the engine coolant temperature is below 105°F (40°) or if the battery charge is insufficient.

To cancel:

- Press  button (indicator lamp goes out).
- Turn key in steering lock to position 2.

The system will automatically shut off:

- after approx. 30 minutes,
- if the engine coolant temperature drops below 105°F (40°),
- if the battery voltage drops.

### Air Recirculation

Outside air is not supplied to the car's interior.

This mode can be selected to prevent annoying odors or dust from entering the car's interior.

To select:

Press  button (indicator lamp lights up).

To cancel:

Press  button (indicator lamp goes out).

The system will automatically switch from recirculated air to fresh air if button  is pressed:

- after approx. 5 minutes at outside temperatures below approx. 40° (5°),

- after approx. 30 minutes, at outside temperatures above approx. 40° (5°).

If button  is pressed:

- after approx. 5 minutes.

Note:

If the windows should fog up from the inside, switch from recirculated air back to fresh air.

At high outside temperatures, the system automatically engages the recirculated air mode thereby increasing the cooling capacity performance.

### Off

The fresh air supply to the car interior is shut off. While driving, use this setting only temporarily, otherwise the windows could fog up.



## Car Keys

Included with your vehicle are

- 2 infrared remote control with folding master key
- 1 Master key
- 1 Valet key
- 1 Flat key

### Master Key with Infrared Remote Control

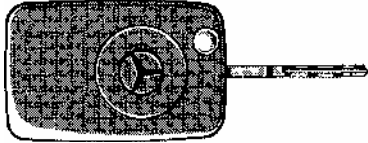

The master key fits all locks on the car.

The transmitter for the infrared remote control is located in the key holder, the receivers are located next to the door locks and below the trunk lock.

### Master Key

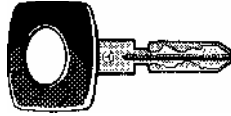

The master key fits all locks on the car.

Note:

Do not give the master key to an unauthorized person.

### Valet Key

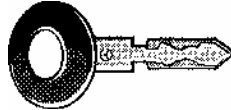

The valet key fits only the door locks and the steering lock.

The valet key will not work in the trunk lock or storage compartment eyeglasses compartment lock in the dashboard.

### Flat Key



The flat key fits all locks on the car.

We recommend that you carry the flat key with you and keep it in a safe place (e.g. your wallet) so that it is always handy. Never leave the flat key in the vehicle.

### Warning!

**When leaving the vehicle always remove the key from the steering lock. Do not leave children unattended in the vehicle. Unsupervised use of vehicle equipment may cause serious personal injury.**

### Obtaining Replacement Keys

Your vehicle is equipped with a theft deterrent locking system requiring a special key manufacturing process. For security reasons, replacement keys can only be obtained via your authorized MERCEDES-BENZ dealer.

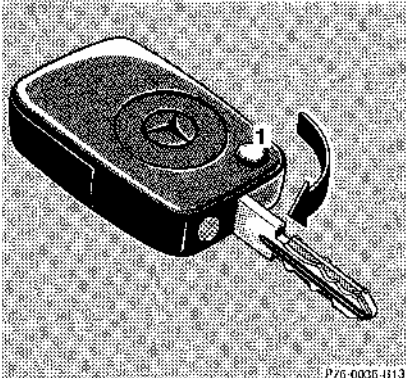

1. Release button for master key

### Master Key in Key Holder

Releasing: press release button (1). The key unfolds from the holder by itself.  
Storing: press release button (1) and fold key back into holder.

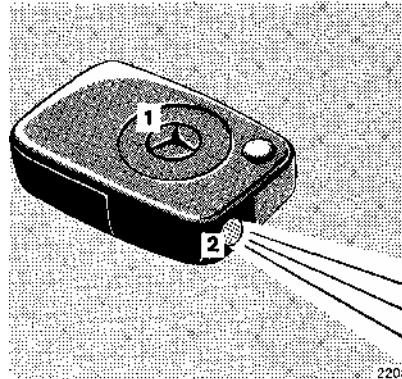

1. Transmit button
2. Transmitter eye and battery check

### Infrared Remote Control

The vehicle can be centrally locked and unlocked with infrared remote control.

The transmitter is located in the key holder, the receivers are located next to the door locks and below the trunk lock.

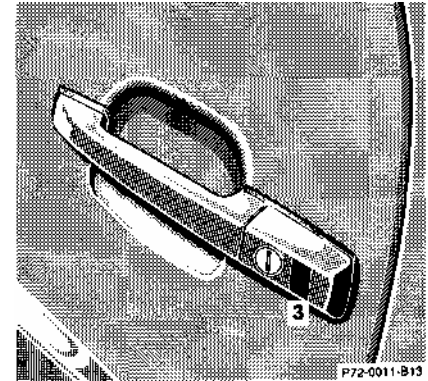

3. Receiver in door handle

### Unlocking:

Aim transmitter eye (2) at a receiver (3) and press transmit button (1).  
Distance to receiver max. 20 ft (6 m).

The green indicator lamps on the receivers should blink. They stop blinking when the vehicle is unlocked.

Note:

If the trunk was previously locked separately, it will remain locked (see Index).

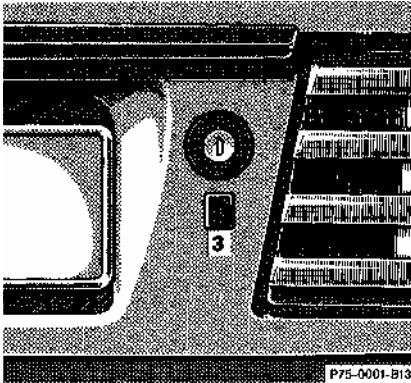

3. Receiver under trunk lock

### Locking:

Aim transmitter eye (2) at a receiver (3) and press transmit button (1). Distance to receiver max. 20 ft (6 m). The red indicator lamps on the receivers should blink. They stop blinking when the vehicle is locked.

### Notes:

If a door or the trunk is not properly closed after you attempt to lock the vehicle by remote control, the red indicator lamps will continue to blink (max. 10 seconds). Open the door or trunk lid, close it properly, and lock the car again.

If the vehicle cannot be locked or unlocked by pressing the transmit button (1), then it may be necessary to change the batteries in the transmitter (if ok, battery indicator lamp in transmitter will light when transmitting) or to synchronize the system, see *Testing Infrared Remote Control* in Index.

### Closing Windows from Outside

Continue to press transmit button (1) after locking car. Distance to receiver max. 10 ft (3 m). The windows begin to close after approx. 1 second.

### Warning!

**Never close the windows if there is the possibility of anyone being harmed by the raising window.**

**In case the closing procedure causes potential danger, the closing procedure can be immediately interrupted by releasing the transmit button. However, the windows can only be lowered using the power window buttons inside the car.**

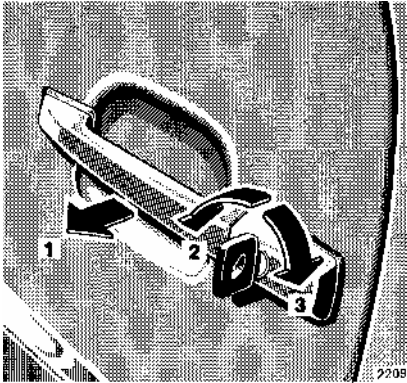

## Central Locking System

The entire vehicle may be locked or unlocked by using the master key in either door or in the trunk lock. The central locking system also locks or unlocks the fuel filler flap.

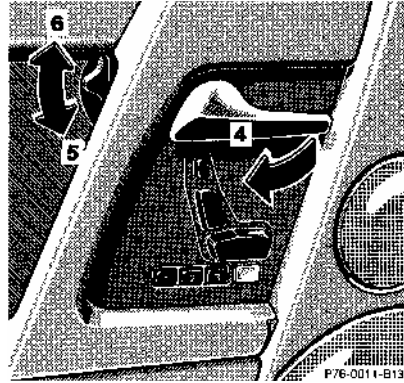

## Locking and Unlocking of Doors

1. Opening - pull handle
2. Unlocking
3. Locking
4. Opening - pull handle
5. Locking
6. Unlocking

### Locking - from outside

- With driver's door closed - turn key to the right (3).
- With passenger's door closed - turn key to the left.

### Locking - from inside

- With the door closed - push the lock lever down (5).

### Unlocking - from outside

- At the driver's door - turn key to the left (2).
- At the passenger's door - turn key to the right.

### Unlocking - from inside

- Push the lock lever up (6). The doors and the trunk are unlocked if previously locked from inside.

If previously locked from outside, only that door will be unlocked (theft deterrence).

### Note:

The central locking system can only be engaged at the passenger door if the key is removed from the steering lock or is inserted in the steering lock without having been turned.

If a door is not properly closed, unlock the car, open and reclose this door, and lock the car again.

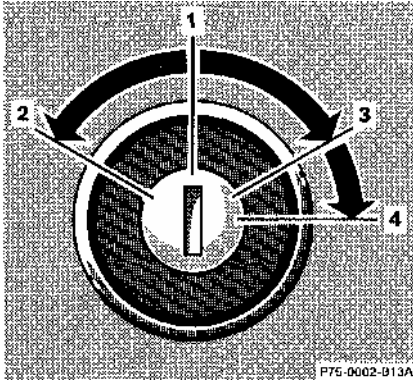

### Locking and Unlocking at Trunk Lock

1. Neutral position - push to open
2. Unlocking
3. Locking (detent)
4. Separate locking of trunk - remove key in this position.

### Locking

Turn master key to position 3, turn back to position 1 and remove.

### Unlocking

Turn master key to position 2, turn back to position 1 and remove.

### Separate Locking and Unlocking of Trunk

If the trunk is to remain locked (e.g. when leaving the car at a parking garage or workshop), lock the trunk separately. Turn master key to position 4 and remove in this position. Leave only the valet key with the vehicle.

The trunk (and fuel filler flap) remain locked - even if the central locking system was engaged from outside and a door is opened from inside of car (theft deterrence).

To unlock turn master key to position 2, then back to position 1 and remove.

If the trunk is unlocked, the doors and fuel filler flap will also be unlocked. After closing the trunk, the central locking system must again be engaged to relock the doors and fuel filler flap.

Note:

If the fuel filler flap cannot be opened, refer to *Manual Release of Fuel Filler Flap* in Index.

## Closing Windows from Outside

Turn key in door lock or trunk lock to the locking position 3 and hold. The windows begin to close after approx. 1 second.

### Note:

If the closing procedure is interrupted, it can only be continued by first turning the key to the unlocked position (2) and then again to the locking position (3).

## Warning!

**Never close the windows if there is the possibility of anyone being harmed by the raising window.**

**In case the closing procedure causes potential danger, the closing procedure can be immediately interrupted by turning the key back to the vertical position. However, the windows can only be lowered using the power window buttons inside the car.**

## Emergency Unlocking in Case of Accident

The doors unlock automatically a short time after the roll bar is deployed in an accident (this is intended to aid rescue and exit). However, the key in the steering lock must be in steering lock positions 1, 2 or returned to position 0, but not removed.

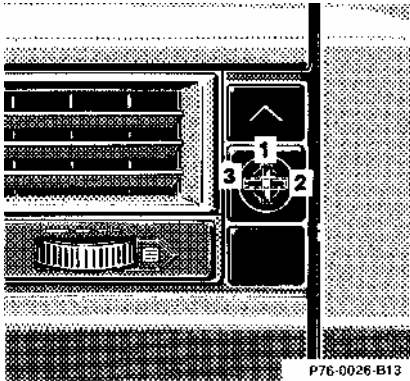

### Interior Central Locking System

1. Initial position (integrated with vehicle central locking system)
2. Separate locking of storage compartments
3. Emergency operation

The following storage compartments are part of the interior central locking system:

- eyeglasses compartment in the dashboard,
- console storage compartments,

- rear storage compartments,
- door pockets.

### Integration with Vehicle Central Locking System

When locking or unlocking the vehicle from the outside by using the master key, the interior storage compartments and door pockets are also locked or unlocked (with lock in position 1).

### Separate Locking of Storage Compartments

Locking:

Turn master key to position 2 and remove from lock. The storage compartments remain locked -even if the vehicle is unlocked from the outside.

Unlocking:

Turn master key to position 1 and remove from lock. If the vehicle was locked from the outside, the storage compartments remain in the locked mode until the vehicle is unlocked again from the outside.

Note:

If the interior storage compartments are to remain locked (for example while in a repair shop), leave only the valet key with the vehicle.

When unlocking a door from the inside, on a vehicle previously locked from the outside, the storage compartments still remain locked.

In case of a malfunction the eye glasses compartment can still be opened. To do so, turn the master key to position 3, return it to position 1, remove it from the lock and press button  .

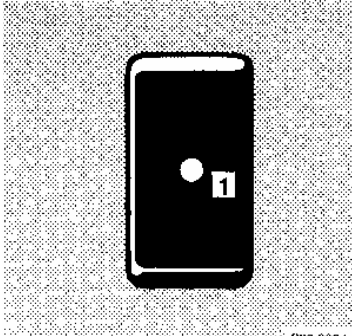

1 Indicator lamp in center console

## Anti Theft Alarm System

The anti-theft alarm is automatically armed after 10 seconds of locking either door or the trunk with any of your vehicle's keys or infrared remote control.

A blinking lamp (1) indicates that the alarm is armed. Now the engine cannot be started.

The anti-theft alarm is disarmed when unlocking either door or the trunk with any of your vehicle's keys or infrared remote control.

Operation:

Once the alarm system has been armed, the exterior vehicle lamps will flash and the horn will sound intermittently when someone:

- opens a door,
- opens the trunk,
- opens the hood,
- removes the radio,
- switches on or bridges the ignition circuit,
- steps on the brake pedal,

- opens the storage compartment between the front seats,

The alarm will last approximately 150 seconds in the form of blinking exterior lamps. At the same time an alarm horn will sound intermittently for 60 seconds, pause for 30 seconds, and repeat for another 60 seconds.

The alarm will stay on even if the activating element (a door, for example) is immediately closed.

Note:

We recommend that you carry the flat key safely with you so that it is always handy. This key has the same function as the master key.



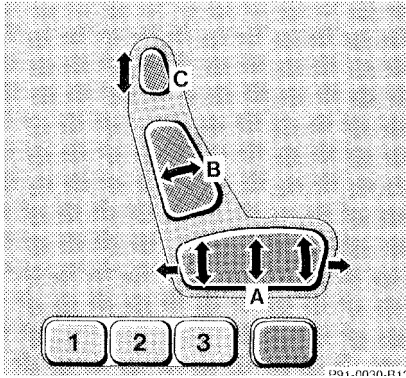

## Power Seats

The switches are located in each front door.

Turn key in steering lock to position 1 or 2 (with either door open, the power seats can also be operated with the key removed or in steering lock position 0).

## Adjusting

- A. Seat cushion
- B. Backrest
- C. Head restraint (with shoulder belt height adjustment)

Adjust the head restraint so that the upper portion of the shoulder belt is located as close as possible to the middle of the shoulder. The head restraint can be tilted forward by hand.

### Note:

To prevent the backrest from touching the soft top storage compartment cover when the seat cushion is moved back, the backrest will automatically move to a more upright position.

When reclining the backrest, the seat cushion will automatically move forward to prevent the backrest from touching the soft top storage compartment cover.

## Warning!

**When leaving the vehicle always remove the key from the steering lock.**

**The power seats can also be operated with the driver's or passenger door open. Do not leave children unattended in the vehicle. Unsupervised use of vehicle equipment may cause serious personal injury.**

**Do not adjust the driver's seat while driving. Adjusting the seat while driving could cause the driver to lose control of the vehicle.**

**Never ride in a moving vehicle with the seat back reclined. Sitting in an excessively reclined position can be dangerous. You could slide under the seat belt in a collision. If you slide under it, the belt would apply force at the abdomen or neck. That could cause serious or even fatal injuries. The seat back and seat belts provide the best restraint when the wearer is in an upright position and belts are properly positioned on the body.**

**The rear storage area should never be occupied by passengers since the vehicle is a 2 seater. Furthermore, there is a risk of injury in the rear by adjusting the power assisted front seats.**

**Never place hands under seat or near any moving parts while a seat is being adjusted.**

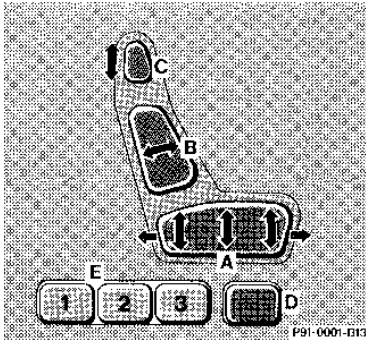

Using the same position button, the steering column position and rear view mirror positions will also be stored together with the seat position. Adjusting steering column and mirrors see Index.

### Recalling Stored Positions

Press position button "1", "2" or "3" and hold until seat/head restraint/steering wheel/mirror movement has stopped.

Note:

For safety reasons, the seat/head restraint/steering wheel/mirror movement stops after releasing the position button.

### Storing Position in Memory

**D** Memory button

**E** Position buttons "1", "2" and "3"

After the seat and head restraint are positioned, push memory button D, release, and within 3 seconds push position button "1". Two additional sets of positions may be stored into memory using position buttons "2" and "3".

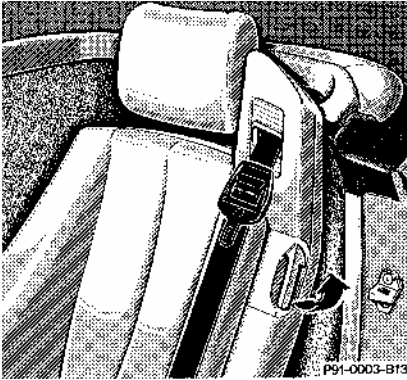

## Backrest

Folding forward:  
Lift lever and fold forwards.

Folding back:  
Fold backrest back until it audibly  
locks in place.

## Warning!

**The seat belts provide protection only with the backrest locked in place and, therefore, must be locked in place with the vehicle in motion. Do not drive the car when the seat-back is not locked in place.**

## Note:

If the backrest and seat belt warning lamp does not go out, but is instead lit continuously, then a backrest is not engaged in its lock.

Always provide sufficient room behind the backrest and fold the backrest all the way back until it can be heard locking in place.

The warning lamp goes out as soon as both backrests are locked in place.

If both backrests are locked in place and the warning lamp does not go out, have the system checked at your authorized Mercedes-Benz dealer immediately.

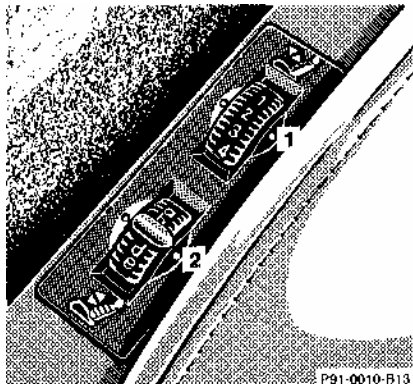

## Orthopedic Seat Backrest

1. Pressure regulator
2. Height regulator

Some seats may be equipped with orthopedic seats. These seats have an inflatable air cushion forward, the backrest provide additional lumbar support. Lock the backrest back until it audibly locks in place.

**Warning!** The pressure and height regulators are located behind the seat for protection, only with the backrest locked in place and, therefore, must be locked in place while the vehicle in motion. Do not adjust the pressure regulator while the seat back is not locked in place.

The inflation pressure of the air cushion backrest on seats is varied between 0.5 and 1.0 bar. The backrest is not pressurized in the upright position. Always provide sufficient room behind the backrest and fold the backrest all the way back. The cushion on the right may be changed to a different setting between the warning lamp does not act on as an 80° backrest setting by replacing the right backrest (2) in its place and the warning lamp does not go out, if the engine system is checked last. The cushion setting is RCFHDS-BINZ dialer and automatically adjusts the cushion to this setting when the engine is restarted.

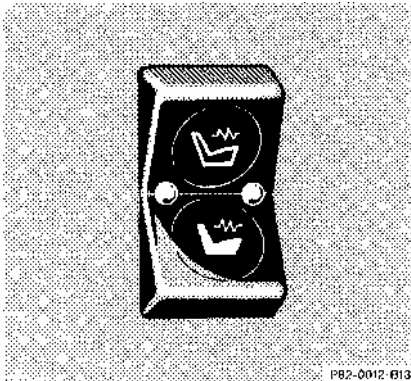

## Heated Seats

The seat heaters can be switched on with the key in steering lock turned to position 1 or 2.

Turning on heater: Press upper half of switch = normal heating mode. One indicator lamp in the switch lights up.

Press lower half of switch = rapid heating mode. Both indicator lamps in the switch light up.

After approximately 5 minutes in the rapid heating mode, the heater automatically switches to normal operation and only one indicator lamp will stay on.

Turning off heater:  
If one indicator lamp is on, press upper half of switch.

If both indicator lamps are on, press lower half of switch.

If left on, the heater automatically turns off after approximately 30 minutes of operation.

Note:

When in operation, the seat heater consumes a large amount of power. It is advisable not to use the seat heater longer than necessary.

The seat heaters may automatically switch off if too many power consumers are switched on at the same time, or if the battery charge is low.

When this occurs, the indicator lamp in the switch will blink (both indicator lamps blink during rapid seat heating). The seat heaters will switch on again automatically as soon as sufficient voltage is available. If the blinking of the indicator lamps is distracting to you, the seat heaters can be switched off.

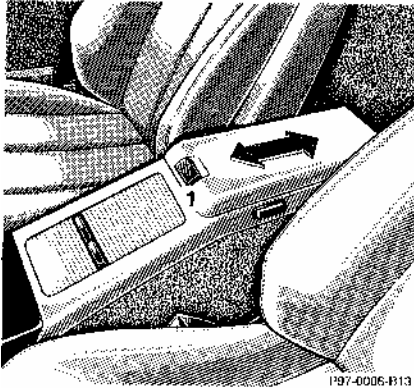

### Armrest

To adjust: Press button (1) and slide armrest forward or backward.

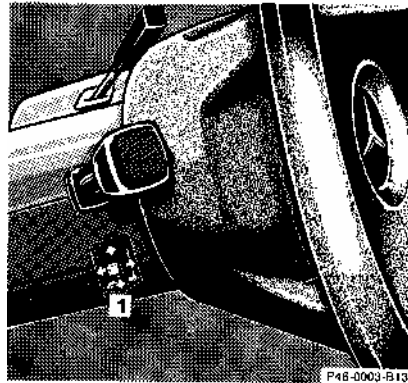

### Adjusting Steering Column

Turn key in steering lock to position 1 or 2 (with either door open, the steering column can be operated with the key removed or in steering lock position 0).

To extend or retract: Move switch (1) in desired direction.

To raise or lower: Move switch (1) in desired direction.

### Storing Steering Column Position in Memory

The steering column position is stored in memory together with the seat/head restraint/mirror position and can be recalled when necessary, see Index.

### Warning!

**Do not adjust the steering wheel while driving. Adjusting the steering wheel while driving could cause the driver to lose control of the vehicle.**

## **Seat Belts and Supplemental Restraint System (SRS)**

Your vehicle is equipped with lap-shoulder seat belts, emergency tensioning retractors for the seat belts, driver airbag and knee bolster and passenger airbag and knee bolster.

### **Seat Belts**

#### **Important!**

Laws in most states and all Canadian provinces require seat belt use.

All states and provinces require use of child restraints that comply with U.S. Federal Motor Vehicle Safety Standard 213 and Canadian Motor Vehicle Safety Standard 213.1. We strongly recommend their use.

#### **Seat Belt Warning System**

With the key in steering lock position 2, an audible warning sounds for a short time if the driver's seat belt is not fastened.

### **Warning!**

**Failure to wear and properly fasten and position your seat belt greatly increases your risk of injuries and their likely severity in an accident. You and your passengers should always wear seat belts.**

**If you are ever in an accident, your injuries can be considerably more severe without your seat belt properly buckled. Without your seat belt buckled, you can hit the interior of the vehicle or be ejected from it. You can be seriously injured or killed.**

**In the same crash, the possibility for injury or death is lessened with your seat belt buckled.**

**The seat belts provide protection only with the backrest locked in place. If the seat belt warning lamp does not go out, but is instead lit continuously, then a backrest is not engaged in its lock.**

**Never ride in a moving vehicle with the seat back reclined. Sitting in an excessively reclined position can be dangerous. You could slide under the seat belt in a collision. If you slide under it, the belt would apply force at the abdomen or neck. That could cause serious or even fatal injuries. The seat back and seat belts provide the best restraint when the wearer is in an upright position and belts are properly positioned on the body.**

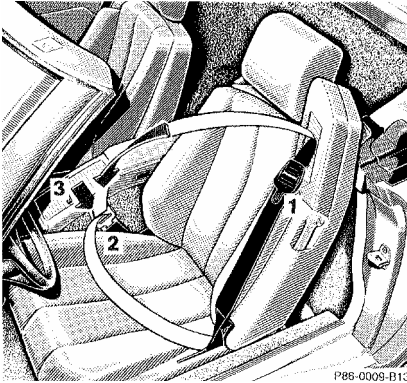

1. Latch plate
2. Buckle
3. Release button

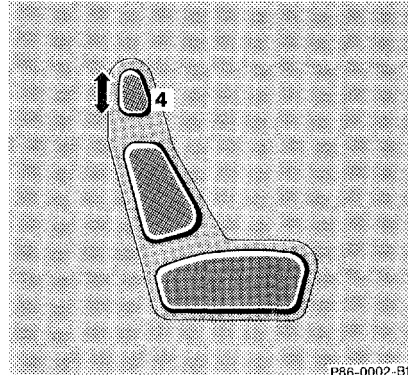

### Fastening of Seat Belts

Pull belt with latch plate (1) across shoulder and lap. Push latch plate (1) into buckle (2) until it clicks. The lap belt should be positioned as low as possible on your hips and not across the abdomen. Do not twist the belt. A twisted seat belt may cause injury. For safety reasons, avoid adjusting the seat or seat back into positions which could affect the correct seat belt position.

Press switch (4) to adjust seat belt so that the shoulder portion is located as close as possible to the middle of your shoulder.

The shoulder portion of the seat belt must be pulled snug and checked for snugness immediately after engaging it and during driving. Tighten the lap portion to a snug fit by pulling shoulder portion up.



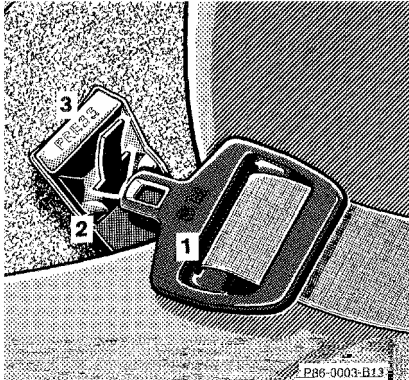

## Unfastening of Seat Belts

Push in the red button (3) in the belt buckle (2).

Allow the retractor to completely rewind the seat belt by guiding the latch plate (1).

## Operation:

The inertia reel stops the belt from unwinding during sudden vehicle stops or when quickly pulling on the belt.

The locking function of the reel may be checked by quickly pulling on the belt.

The emergency tensioning retractors tighten the fastened seat belts during frontal and front-angled impacts exceeding the first threshold of the SRS (see Index).

## Note:

For cleaning and care of the seat belts, see *Cleaning and Care of the Vehicle* in Index.

## Warning!

### USE SEAT BELTS PROPERLY.

- Each occupant should wear their seat belt at all times. Together with the "SRS", the seat belt offers the best conditions for protection of the body in case of major frontal impact.
- Improperly positioned seat belts do not provide maximum protection and may cause serious injuries in case of an accident.
- Never wear the shoulder belt under your arm, against your neck or off your shoulder. In a crash, your body would move too far forward. That would increase the chance of head and neck injuries. The belt would also apply too much force to the ribs, which could severely injure internal organs such as your liver or spleen.

- Position the lap belt as low as possible on your hips and not across the abdomen. If the belt is positioned across your abdomen, it could cause serious injuries in a crash.
- Each seat belt should never be used for more than one person at a time. Do not fasten a seat belt around a person and objects.
- Belts should not be worn twisted. In a crash, you wouldn't have the full width of the belt to take impact forces. The twisted belt against your body could cause injuries.
- Pregnant women should also use a lap-shoulder belt. The lap belt portion should be positioned as low as possible on the hips to avoid any possible pressure on the abdomen.

### USE CHILD RESTRAINTS PROPERLY.

- Infants and small children must be seated in an infant or child restraint system, which is properly secured by a lap belt or lap belt portion of a lap-shoulder belt. Children could be endangered in an accident if their child restraints are not properly secured in the vehicle.
- Rear-facing child restraints must not be used in the front seat. They could be struck by the airbag when it inflates in a crash. If this happens, a child in the restraint could be seriously injured.
- Children too big for child restraint systems should use regular seat belts. Position shoulder belt across chest and shoulder, not face or neck. A booster seat may be necessary to achieve proper belt positioning.

## **Supplemental Restraint System (SRS)**

The SRS uses two crash severity levels (thresholds) to activate either the ETR or airbag or both. Activation depends on the direction and severity of the impact, exceeding the thresholds and fastening of the seat belt.

### Seat belt fastened

- first threshold exceeded: ETR activates
- second threshold exceeded: airbag also activates

### Seat belt not fastened

- first threshold exceeded: airbag activates, but not ETR

Driver and front passenger systems operate independently from each other.

## **Emergency Tensioning Retractor (ETR)**

The seat belts are equipped with emergency tensioning retractors. These tensioning retractors are located in each belt's inertia reel and become operationally ready with the key in steering lock position 1 or 2.

The emergency tensioning retractors are designed to activate only when the seat belts are fastened during frontal and front-angled impacts exceeding the first threshold of the SRS. They remove slack from the belts in such a way that the seat belts fit more snugly against the body, restricting its forward movement as much as possible.

In cases of other frontal impacts, roll-overs, certain side impacts, rear collisions, or other accidents without frontal forces, the emergency tensioning retractors will not be activated. The driver and passenger will then be protected by the fastened seat belts and inertia reel in the usual manner.

For seat belt and emergency tensioning retractor safety guidelines, see *Safety Guidelines* in Index.

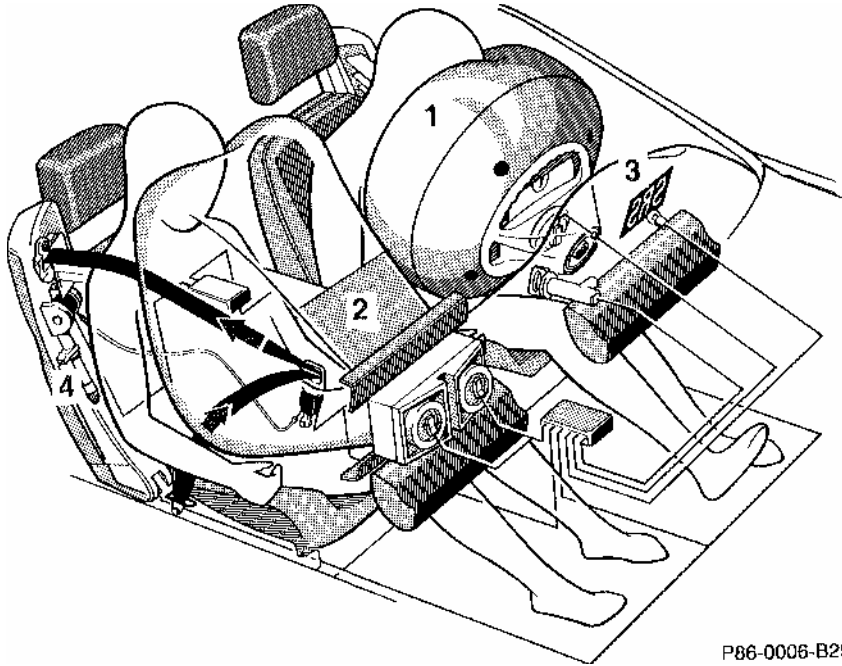

P86-0006-B25

## Airbags

The most effective occupant restraint system yet developed for use in production vehicles is the seat belt. In some cases, however, the protective effect of a seat belt can be further enhanced by an airbag.

The driver airbag (1) is located in the steering wheel hub. The passenger airbag (2) is located in the dashboard ahead of the passenger. In conjunction with wearing the seat belts with emergency tensioning retractors (4), they provide increased protection for the driver and passenger.

The operational readiness of the airbag system is verified by the indicator lamp "SRS" (3) in the instrument cluster. If no fault is detected, the lamp will go out after approximately 4 seconds; after the lamp goes out, the system continues to monitor the components and circuitry of the airbag system and will indicate a malfunction by coming on again.

The following system components are monitored or undergo a self-check: crash-sensor, airbag ignition circuits, driver and passenger seat belt buckles. Initially, when the key is turned from steering lock position 0 to positions 1 or 2, malfunctions in the crash-sensor are detected and indicated (the "SRS" indicator lamp stays on longer than 4 seconds).

In the operational mode, after the indicator lamp has gone out following the initial check, interruptions and short circuits in the airbag ignition circuit and in the driver and passenger seat belt buckle harnesses, and low voltage in the entire system are detected and indicated.

In the event a malfunction of the "SRS" is indicated as outlined above, the "SRS" may not be operational. We strongly recommend that you visit an authorized Mercedes-Benz dealer immediately to have the system checked; otherwise the "SRS" may not be activated when needed.

### **Important!**

**The airbags are designed to activate only in certain frontal and front-angled impacts. Only during these types of impacts will they provide their supplemental protection. The driver and passenger should always wear the seat belts, otherwise it is not possible for the airbags to provide their intended supplemental protection.**

**In cases of other frontal impacts, roll-overs, certain side impacts, rear collisions, or other accidents without frontal forces, the airbags will not be activated. The driver and passenger will then be protected by the fastened seat belts.**

**We caution you not to rely on the presence of an airbag in order to avoid wearing your seat belt.**

### **Important!**

**The "SRS" is designed to reduce the potential of injury in certain frontal and front-angled impacts which may cause injuries, however, no system available today can totally eliminate injuries and fatalities.**

**The activation of the "SRS" temporarily releases a small amount of dust from the air-bags. This dust, however, is neither injurious to your health, nor does it indicate a fire in the vehicle.**

**The service life of the airbags extends to the date indicated on the label located on the driver-side door latch post. To provide continued reliability after that date, they should be inspected by an authorized Mercedes-Benz dealer at that time and replaced when necessary.**

## **Warning!**

**It is very important for your safety to always be in a properly seated position and to wear your seat belt. For maximum protection in the event of a collision always be in normal seated position with your back against the seat back. Fasten your seat belt and ensure that it is properly positioned on the body.**

**Since the airbag inflates with considerable speed and force, a proper seating position will keep you in a safe distance from the airbag:**

- **Sit properly belted in an upright position with your back against the seat back.**
- **Do not lean with your head or chest close to the steering wheel or dashboard.**
- **Adjust the driver seat as far as possible rearward, still permitting proper operation of vehicle controls.**
- **Adjust the passenger seat as far as possible rearward from the dashboard, especially when a child restraint is installed.**

- **Infants and small children should only be seated in an infant or child restraint which is properly secured by the seat belt.**
- **Rear-facing child restraints must not be used in a front seat.**

**Failure to follow these instructions can result in severe injuries to you or other occupants.**

## Safety Guidelines for the Seat Belt, Emergency Tensioning Retractor and Airbag

### Warning!

- **Damaged belts or belts that were highly stressed in an accident must be replaced and their anchoring points must also be checked. Use only belts installed or supplied by an authorized Mercedes-Benz dealer.**
- **Do not pass belts over sharp edges.**
- **Do not make any modification that could change the effectiveness of the belts.**
- **The "SRS" is designed to function on a one-time-only basis. An airbag or emergency tensioning retractor (ETR) that was activated must be replaced.**

- **No modifications of any kind may be made to any components or wiring of the "SRS". This includes the installation of additional trim material, badges etc. over the steering wheel hub or front passenger airbag cover and installation of additional electrical/electronic equipment on or near "SRS" components and wiring.**
- **Several airbag system components at the steering wheel get hot after the air-bag has inflated. Don't try to touch them.**
- **Improper work on the system, including incorrect installation and removal, can lead to possible injury through an uncontrolled activation of the "SRS".**

- **In addition, through improper work there is the risk of rendering the "SRS" inoperative. Work on the "SRS" must therefore only be performed by an authorized Mercedes-Benz dealer.**
- **When scrapping the airbag unit or emergency tensioning retractor, it is mandatory to follow our safety instructions. These instructions are available at your authorized Mercedes-Benz dealer.**

When you sell the vehicle we strongly urge you to give notice to the subsequent owner that it is equipped with an "SRS" by alerting him to the applicable section in the Owner's Manual.

## **Infants and Child Restraint Systems**

We recommend that all infants and children be restrained at all times while the vehicle is in motion.

### **Important!**

The use of infant or child restraints is required by law in all 50 states and all Canadian provinces.

Infants and small children should be seated in an infant or child restraint system, which is properly secured by the lap belt portion of the lap-shoulder belt, and that complies with U.S.

Federal Motor Safety Standard 213 and Canadian Motor Vehicle Safety Standard 213.1.

A statement by the child restraint manufacturer of compliance with this standard can be found on the instruction label on the restraint and in the instruction manual provided with the restraint.

When using any infant or child restraint system, be sure to carefully read and follow all manufacturer's instructions for installation and use.

### **Warning!**

**Rear-facing child restraints must not be used in a front seat. They could be struck by the airbag when it inflates in a crash. If this happens, a child in the restraint could be seriously injured.**

**Infants and small children should never be held on the lap while the vehicle is in motion. During an accident they would be almost impossible to hold, and could be crushed between the adult and the dashboard.**

**Infants and small children should never share a seat belt with another occupant. During an accident, they could be crushed between the occupant and seat belt.**

**Children too big for child restraint systems should use regular seats belts. Position the shoulder belt across the chest and shoulder, not the face or neck. A booster seat may be necessary to achieve proper belt positioning.**

**When the child restraint is not in use, remove it from the car or secure it with the seat belt to prevent the child restraint from becoming a projectile in the event of an accident.**

U.S.A. Models only

Since 1986 all U.S. child restraints comply with U.S. regulations without the use of a tether strap.

Canada Models only

This vehicle can be equipped with tether anchorages for a top tether strap. Consult your authorized Mercedes-Benz dealer for installation of these anchorages.



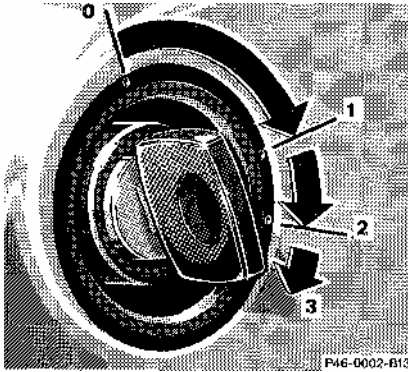

## Steering Lock

0. The key can be withdrawn in this position only. The steering is locked with the key removed from the steering lock. The key can be removed only with the selector lever in position "P". After removing the key or with the key in steering lock position 0, the selector lever is locked in position "P".

1. Steering is unlocked.  
(If necessary, move steering wheel slightly to allow the key to be turned clockwise to position 1.) Most electrical consumers can be operated. For detailed information see respective subjects.
2. Driving position.
3. Starting position.

Refer to Index for *Starting and turning off engine*.

## Warning!

**When leaving the vehicle always remove the key from the steering lock. Do not leave children unattended in the vehicle. Unsupervised use of vehicle equipment may cause serious personal injury.**

## Notes:

A warning will sound when the driver's door is opened with the key in steering lock positions 1 or 0.

With the engine at idle speed, the charging rate of the alternator (output) is limited.

It is therefore recommended to turn off unnecessary electrical consumers while driving in stop-and-go traffic. This precaution helps to avoid draining of the battery.

Unnecessary drain on the battery and charging system may be minimized by turning off the following power consumers, for example: heated seats, rear window defroster. In addition, the automatic climate control blower speed should be set to stage "1".

## Caution!

To prevent accelerated battery discharge and a possible dead battery, always remove the key from the steering lock. **Do not** leave the key in steering lock position 0.

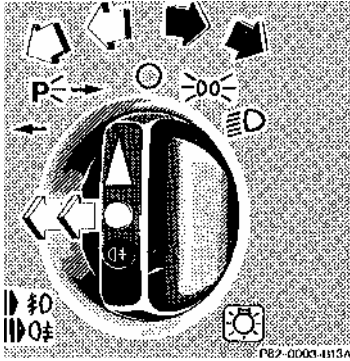









### Exterior Lamp Switch

Canada only:

When the engine is running, the low beam (includes parking lamps, side marker lamps, taillamps, license plate lamps and instrument panel lamps) are automatically switched on.

Note:

For nighttime driving the exterior lamp switch should be turned to position  to permit activation of the high beam headlamps.

	Off
	Parking lamps (includes side marker lamps, taillamps, license plate lamps, instrument panel lamps) Canada only: When the engine is running, the low beam is additionally switched on.
	Parking lamps plus low beam or high beam headlamps (combination switch pushed forward)
	Standing lamps, right (turn left one stop).
	Standing lamps, left (turn left two stops)
	Fog lamps (pull out one stop) with parking and/or headlamps on
	Rear fog lamp (pull out to 2nd detent) In addition to fog lamps. Indicator lamp in lamp switch comes on

### Standing Lamps

When the vehicle is parked on the street the standing lamps (right or left side parking lamps) can be turned on, making the vehicle more visible to passing vehicles.

The standing lamps can only be operated with the key in steering lock position 0 or 1.

Note:



With the key removed and a door open, an audible warning will sound if the vehicle's exterior lamps (except standing lamps) are not switched off.

Fog lamps will operate with the parking lamps and the low or high beam headlamps. Fog lamps should only be used in conjunction with low beam headlamps. Consult your state Motor Vehicle Regulations regarding allowable lamp operation.

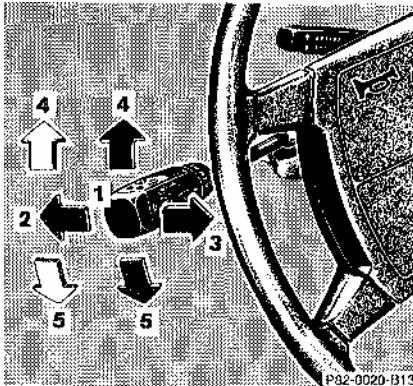
Fog lamps are automatically switched off when the exterior lamp switch is turned to position 0.



### Combination Switch

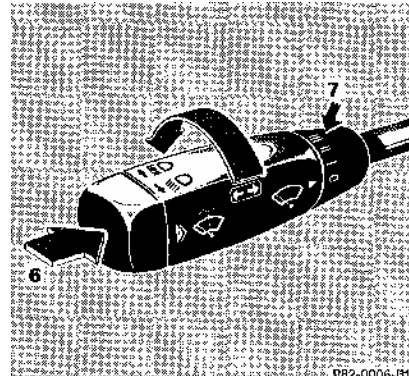

1. Low beam (exterior lamp switch position )
2. High beam (exterior lamp switch position )
3. High beam flasher (high beam available independent of exterior lamp switch position)
4. Turn signals, right
5. Turn signals, left



To signal minor directional changes, such as changing lanes on a highway, move combination switch to the point of resistance only and hold it there.

To operate the turn signals continuously, move the combination switch past the point of resistance (up or down). The switch is automatically canceled when the steering wheel is turned to a large enough degree.

6. Press switch briefly:  
One wipe without washer water (select only if window is wet)

Press switch past resistance point: Windshield washer, windshield wiper; headlamp cleaning system (only in exterior lamp switch positions  or .

Canada only: also in position  when the engine is running)

7. Windshield wiper  
Wiper off  
I Intermittent wiping  
II Normal wiper speed  
III Fast wiper speed

When coming to a stop or driving slower than approx. 16 mph (25 km/h), the wiper speed automatically switches to the next lower setting.

In setting "I", the interval between wiper is lengthened.

Upon accelerating again, the wiper speed returns to the previous setting.

Note:

The windshield washer reservoir, hoses and nozzles are automatically heated.

### **Windshield Washer Fluid Mixing Ratio**

For temperatures above freezing:  
MB Windshield Washer Concentrate "S" and water 1 part "S" to 100 parts water (40 ml "S" to 1 gallon water).

For temperature below freezing:  
MB Windshield Washer Concentrate "S" and commercially available premixed windshield washer solvent/antifreeze 1 part "S" to 100 parts solvent (40 ml "S" to 1 gallon solvent).

### **Windshield Wiper Smears**

If the windshield wiper smears the windshield, even during rain, activate the washer system as often as necessary. The fluid in the washer reservoir should be mixed in the correct ratio.

### **Blocked Windshield Wiper**

If the windshield wiper becomes blocked (for example, due to snow), switch off the wiper motor. For safety reasons before removing ice or snow, remove key from steering lock. Remove blockage. Activate combination switch again (key in steering lock position 1).

### **Emergency Operation of Windshield Wiper**

In case of windshield wiper malfunction, turn combination switch to wiper setting II.

Have the system checked at your authorized MERCEDES-BENZ dealer as soon as possible.

### **Signaling Turns with Hazard Flasher in Use**

For example, when the vehicle is being towed (key in steering lock turned to position 2):  
With hazard flasher on, activate combination switch for left or right turn signal - only the selected turn signal will blink.  
Upon canceling the turn signal, all four turn signals will operate again.

### **Turn Signal Failure**

If one of the turn signals fails, the turn signal indicator system flashes and sounds at a faster than normal rate. In addition, the exterior lamp failure indicator will come on.

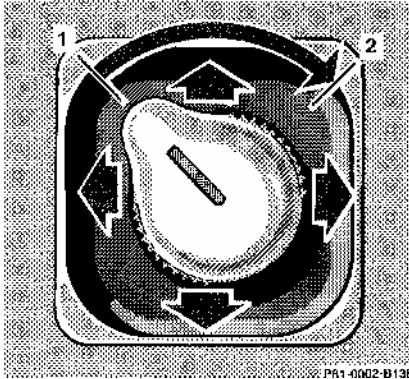

### Exterior Rear View Mirrors

The switch is located in the center console.

Turn key in steering lock to position 2.

First select the mirror to be adjusted - turn switch:

- 1 Left mirror
- 2 Right mirror

To adjust, move the switch forward, backward or to either side.

### Warning!

**Exercise care when using the passenger-side mirror. The passenger-side exterior mirror is convex (outwardly curved surface for a wider field of view). Objects in mirror are closer than they appear. Check your inside rear view mirror or glance over your shoulder before changing lanes.**

Note:

The exterior mirrors have electrically heated glass. The heater switches on automatically, depending on outside temperature.

If the mirror housing is forcibly pivoted from its normal position, it must be repositioned by applying firm pressure until it snaps into place.

### Storing Mirror Positions in Memory

The exterior rear view mirror positions are stored in memory with the seat/head restraint/ steering column position and can be recalled when necessary, see Index.

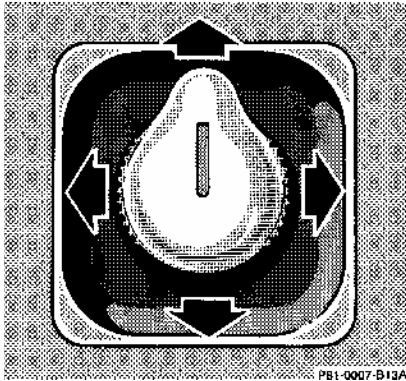

### Inside Rear View Mirror, Electrically Adjustable

The switch is located in the center console. Turn key in steering lock to position 2.

Turn the switch for the exterior rear view mirror adjustment to its center position and adjust by moving the switch forward, backward or to either side.

### Antiglare Night Position

With the key in steering lock position 2, the mirror reflection brightness responds to changes in light sensitivity.

### Storing Mirror Positions in Memory

The exterior rear view mirror positions are stored in memory with the seat/head restraint/ steering column position and can be recalled when necessary, see Index.

Note:

If the inside rear view mirror was adjusted separately, the originally stored position remains in memory. To recall position, press the desired position button.

### Instrument Lamps

Rotate adjusting knob (1) to vary intensity of instrument lamps.

### Trip odometer

To reset:

- Press adjusting knob (1) once (with key in steering lock position 2).
- Press adjusting knob (1) twice (with key removed or in steering lock position 0 or 1).

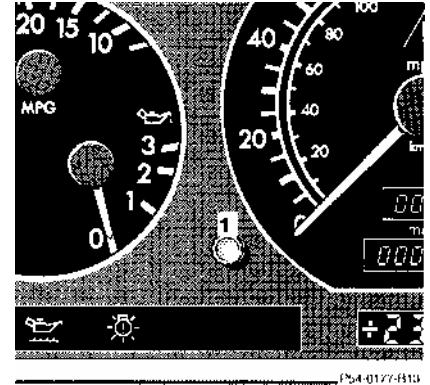

### 1. Adjusting knob

### Display Illumination

Press adjusting knob to briefly illuminate the display (with key removed or in steering lock position 0 or 1).

With exterior lamps switched on the display illumination becomes automatically dim.

Rotate adjusting knob clockwise to its stop to override the dimmed illumination.

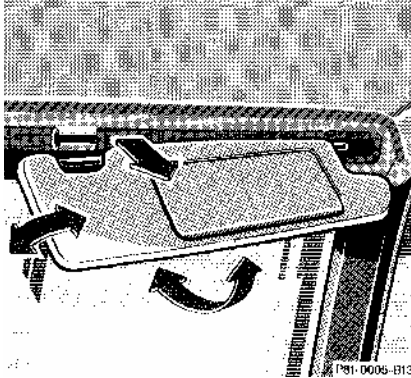

### Sun Visors

Swing sun visors down to protect against sun glare.

If sunlight enters through a side window, disengage visor from inner mounting and pivot to the side. From this position, the visor can slide forward and backward on its shaft.

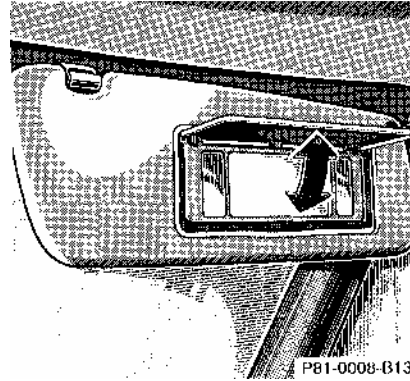

Vanity mirror:

With the visor engaged in its inner mounting, the lamp can be switched on by opening the cover.

### Warning!

**Do not use the vanity mirror while driving.**

### Setting Clock

Location of knob, see *Instrument Cluster* in Index.

Adjusting clock ahead:  
Pull out adjustment knob, turn to the right and hold.

Adjusting clock back:  
Pull out adjustment knob, turn to the left and hold.

Adjusting clock one minute ahead or back:

Pull out adjustment knob, briefly turn to the left or right and release knob.

Adjusting clock more than one minute ahead or back: Pull out adjustment knob, turn to the left or right and hold until the desired time is set.

Adjusting speed: Within the first 2 seconds, the minute hand advances 8 minutes and advances another 8 minutes every additional second thereafter.

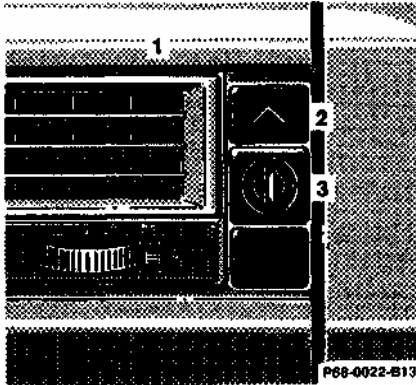

### Storage Compartment (Eyeglasses Compartment) in the Dashboard

1. Storage compartment  
(eyeglasses compartment)
2. Button for storage compartment
3. Lock

Opening compartment (1): Press button (2).

#### Note:

The storage compartments and door pockets may be locked and unlocked by using the master key in lock (3). For interior central locking system see Index.

#### Locking:

Turn master key in lock (3) to the right and remove.

#### Unlocking:

Turn master key back to vertical position.

#### Caution!

Keep compartment lids closed. This will prevent stored objects from being thrown about and injuring vehicle occupants during an accident.

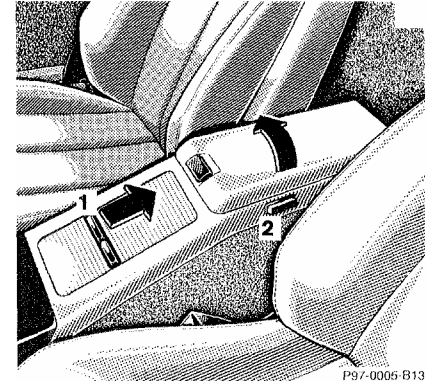

### Console Storage Compartments

To open front compartment (cassette storage): Slide cover (1) back.

Opening rear compartment: Press button (2).

The compartments can be locked and unlocked with the central locking system.



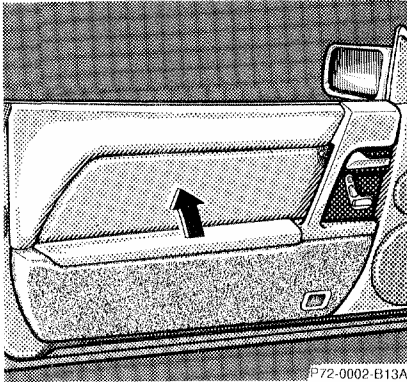

### Door Pockets

To open: Lift cover.

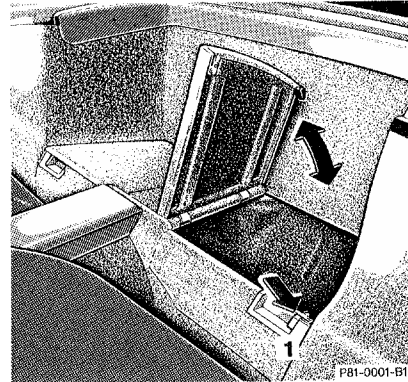

### Rear Storage Compartments

To open compartment:  
Press button (1) and lift cover.

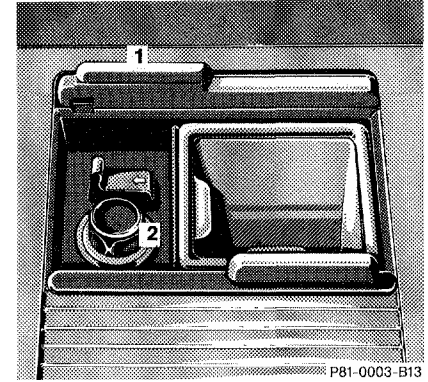

### Lighter

1. Cover
2. Lighter

Turn key in steering lock to position 1 or 2.

Slide cover (1) forward.  
Push in lighter (2); it will pop out automatically when hot.

### Warning!

**Never touch the heating element or sides of the lighter, hold at knob only.**

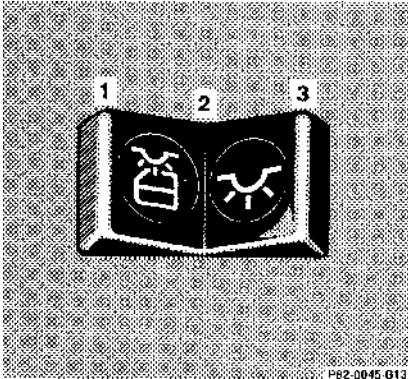

### Interior Lighting

The switch is located above the inside rear view mirror.

### Interior Lamp

1. Interior lamps are switched on, and off delayed, when unlocking or locking the vehicle, or when opening either door.  
However, there will be no delay when the key is in steering lock position 2.
2. Interior lamps switched off.
3. Interior lamps switched on continuously.

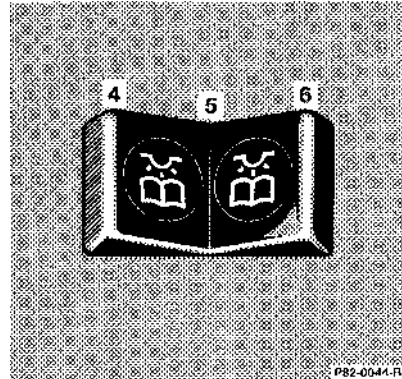

### Reading Lamps

4. Left reading lamp switched on.
5. Reading lamps switched off.
6. Right reading lamp switched on.

### Entrance Lamps, Exit Lamps

Entrance lamps are located in the footwells under the dashboard.

Exit lamps are located in the door pockets.

These lamps are switched on and off by the door contact switches.

Note:

To prevent the vehicle battery from being discharged, do not leave doors open for a long period of time.

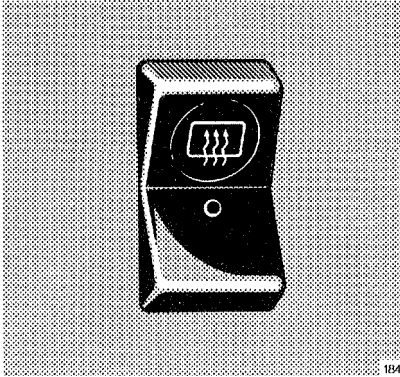

### **Rear Window Defroster**

The switch is located in the center console.

Turn key in steering lock to position 1 or 2.

When activating the rear window defroster, the indicator lamp in the switch will come on.



#### **Note:**

The rear window defroster uses a large amount of power. To keep the battery drain to a minimum, turn off the defroster as soon as the window is clear. The defroster is automatically turned off after a maximum of 20 minutes of operation. Heavy accumulation of snow and ice should be removed before activating the defroster.

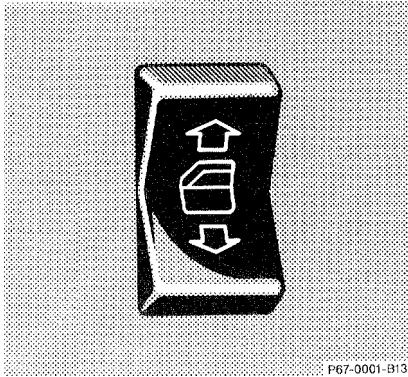

If several power consumers are turned on simultaneously, or the battery is only partially charged, it is possible that the defroster will automatically turn itself off. When this happens, the indicator lamp inside the switch starts blinking. As soon as the battery has sufficient voltage, the defroster automatically turns itself back on.



Press switch up to resistance point:

 to close  
 to open

Release switch when window is in desired position.

Press switch  past resistance point and release - window lowers to fully open position. To interrupt procedure, briefly press  or .

## Power Windows

The switch is located in the center console.  
Turn key in steering lock to position 2.

## Warning!

**When leaving the vehicle, always remove the key from the steering lock. Do not leave children unattended in the vehicle. Unsupervised use of vehicle equipment may cause serious personal injury.**

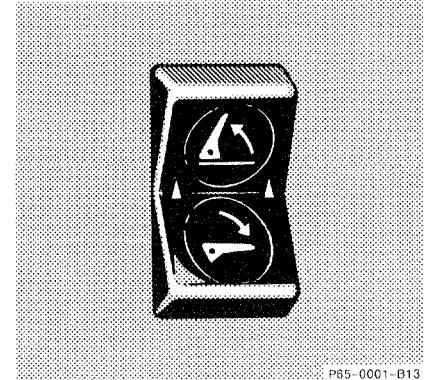

## Roll Bar

The switch is located in the center console.  
Turn key in steering lock to position 2.  
Press switch  
Upper half = to raise  
Lower half = to lower  
The lowering or raising procedure is immediately interrupted by releasing the roll bar switch.

If the roll bar was raised using the switch, it will be automatically lowered when activating the soft top switch.

The roll bar will be automatically raised in an accident or in a potentially dangerous driving situation. A ratchet noise can be heard when the roll bar is automatically raised.

The roll bar can be lowered again after an automatic deployment by pressing the upper half of the roll bar switch (for at least 5 seconds) until the roll bar drive mechanism audibly engages. Then press the lower half of the switch to lower the roll bar.

### **Warning!**

**This vehicle is a two occupant vehicle. The rear storage area should never be used by any persons. Raising or lowering of the roll bar could injure rear seated occupants.**

**Before operating the roll bar switch make sure that the roll bar's path is clear and no persons due to inattention are injured by the moving roll bar.**

**For your own safety we recommend to drive with the roll bar raised, if**

- **the outside temperature is below -15°C (5°F)**
- **the soft top is closed and pets are placed in the rear storage area.**

Items being transported in the area behind the seats should be placed in such a manner as not to affect the movement of the roll bar when being raised.

Note:

If the indicator lamps in the switch are blinking or if the warning lamp in the instrument cluster comes on, then a malfunction has been detected.

In this case, drive only with the roll bar raised until the defect has been repaired. Raise the roll bar by pressing the upper half of the roll bar switch. The indicator lamps in the switch will go out, however, the warning lamp in the instrument cluster will stay on.

Have the system checked at your authorized MERCEDES-BENZ dealer as soon as possible.

### **Important!**

The roll bar is intended to be a safety enhancement to the other features designed into the vehicle. No system in any vehicle can eliminate the possibility of serious injury or fatality in an accident. Properly fastened seat belts and child restraints must be used!

## Hardtop

The removal or attachment of the hardtop can be carried out by 2 persons.

### Warning!

**Do not place your hands between the hardtop and the car body while the hardtop is being locked or unlocked. Serious personal injury may occur.**

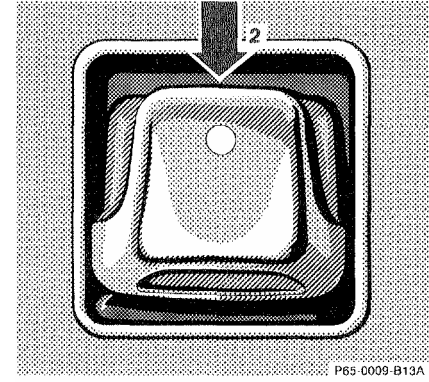
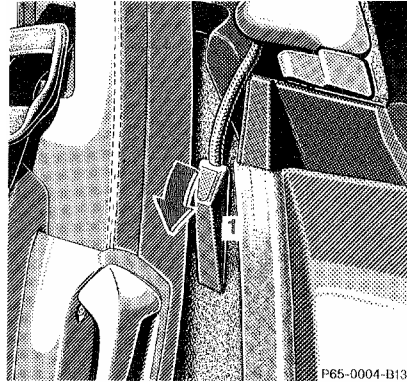

### Removing Hardtop

1. Engage parking brake.
2. Open doors.
3. Disconnect plug (1) for rear window defroster.
4. Within 10 seconds of turning key in steering lock to position 2 (engine not running), slide soft top switch (2) back and hold.

Please note, if soft top switch is activated after 10 seconds have expired, turn the key back to position 0 first before the hardtop removing procedure can be started again at step 4.

The unlocking procedure begins after approx. 2 seconds:

- The roll bar lowers.
- The indicator lamp in the soft top switch lights up.
- The hardtop unlocks.

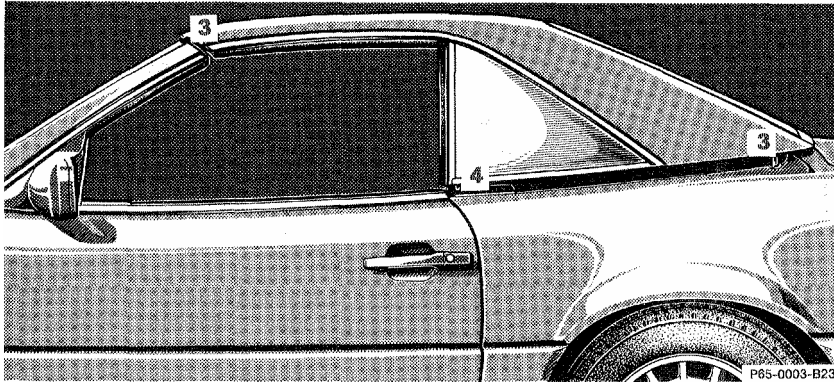

5. After the hardtop has unlocked remove the key from the steering lock and turn radio off to lower antenna. The indicator lamp in the soft top switch should go out.

**Important!**

Removal of the key from the steering lock is a safety measure ensuring that the key cannot be turned to position 2 and the soft top switch is without function should anybody push the switch forward causing the roof locking mechanism to work. If hands are at that moment between roof and car body they can be badly injured.

6. Lift the hardtop vertically from its attachment points (3) and locating points (4) and carefully remove to the rear. Exercise caution when maneuvering the top. To avoid paint damage, the top's mounting pins must not be allowed to contact the body.

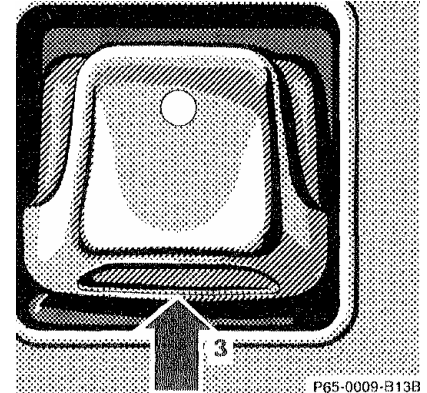
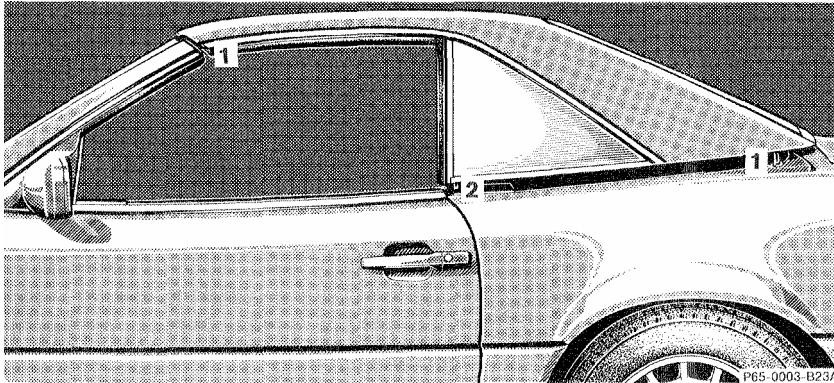

### Attaching Hardtop

1. Engage parking brake and turn key in steering lock to position 2,
2. Lower roll bar,
3. Open doors or windows.
4. Turn radio off to lower power antenna, turn key in steering lock to position 0 and remove.
5. From the rear of the vehicle, lift the hardtop carefully over the attachment points (1) and locating points (2). First guide the rear pins of the top vertically into the rear attachment points, then lower the roof onto the vehicle and locate the front locking pins. Exercise caution when maneuvering the top. To avoid paint damage, the top's mounting pins must not be allowed to contact the body.
6. Turn key in steering lock to position 2. The indicator lamp in the soft top switch lights up.
7. Slide soft top switch (3) forward - the hardtop should lock and the indicator lamp in the switch should go out.



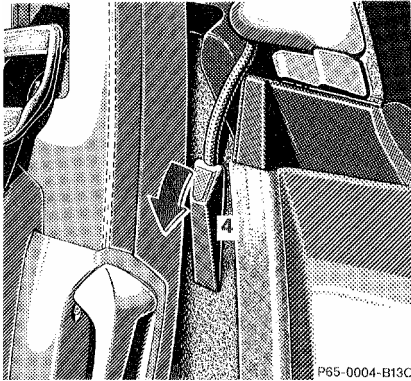

8. Connect plug (4) for rear window defroster.

### **Warning!**

**The raising or lowering procedure of the soft top is not completed if the indicator lamp in the soft top switch:**

- **does not go out (with key in steering lock position 2),**
- **blinks when starting to drive and an alarm sounds.**

**When safe to do so, immediately stop the vehicle and lock the soft top:**

- **Turn key in steering lock to position 2,**
- **Slide soft/hardtop switch forward.**

**Do not drive the car with the hardtop not locked, as that could cause personal injury to you or your passenger, or personal injury or property damage to others.**

### **Note:**

For safety reasons, the hardtop can only be unlocked while the vehicle is standing still, and within 10 seconds after turning the key to steering lock position 2 or beyond.

If the indicator lamp in the soft top switch blinks while activating the switch, the battery voltage may be insufficient - start engine to charge battery before shutting engine off and attempting to unlock the roof again.

If the indicator lamp continues to blink, lock the hardtop manually. See Index.

Have the system checked at your authorized Mercedes-Benz dealer as soon as possible.

## Soft Top

A minimum height clearance of 2 meters (6.5 ft) is required to lower or raise the soft top.

Do not lower a frozen soft top until thawed and dry.

The soft top must be dry before lowering it into the storage compartment.

The soft top should not be lowered or raised at outside temperatures below + 5°F (-15°C)

The lowering or raising procedure is immediately interrupted by releasing the soft top switch.

### Warning!

**Before operating the soft top switch make sure that no persons due to inattention are injured by the moving parts (roll bar, soft top frame and soft top lid).**

**Hands must never be placed near the roll bar, soft top frame, upper windshield area or soft top**

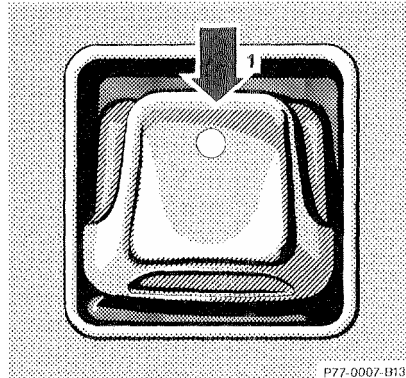

**storage compartment while the soft top is being locked or unlocked. Serious personal injury may occur.**

### Lowering Soft Top

1. Engage parking brake.
2. Turn key in steering lock to position 2.
3. Slide soft top switch (1) back and hold:

- The side windows lower
- The roll bar lowers.
- The indicator lamp in the soft top switch lights up.
- The soft top is lowered into the soft top storage compartment.
- The storage compartment cover closes and locks.
- The indicator lamp in the switch goes out – the lowering procedure is completed.

If the soft top switch is held or is released and slid back again within approx. 2 seconds, the side windows will close. If the roll bar was previously in the upright position, it will return to that position.

However, the side windows and the roll bar can also be activated using their respective switches.

Note:

A wet or frozen soft top must not be folded until thawed and dry.

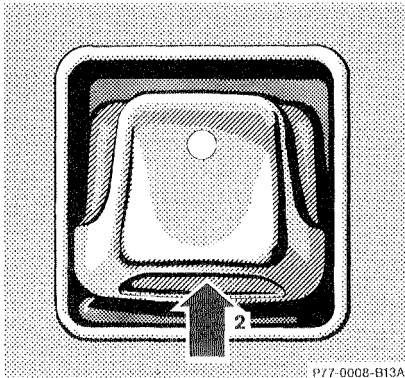

### Raising Soft Top

1. Engage parking brake.
2. Turn key in steering lock to position 2.
3. Fold down sun visors.

4. Slide soft top switch (2) forward and hold:

- The side windows lower.
- The roll bar lowers.
- The indicator lamp in the soft top switch lights up.
- The soft top closes and locks.
- The indicator lamp in the soft top switch goes out -the closing procedure is completed.

If the soft top switch is held or is released and slid forward again within approx. 2 seconds, the side windows will close. If the roll bar was previously in the upright position, it will return to that position.

However, the side windows and the roll bar can also be activated using their respective switches.

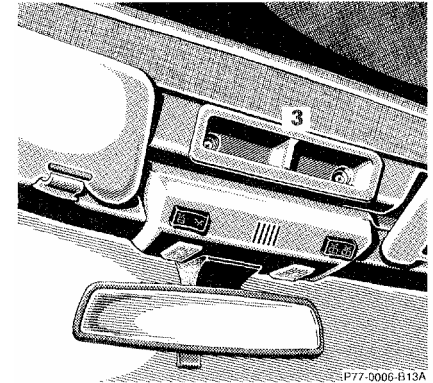

Note:

If the soft top does not engage in the windshield header attachment points, then release the soft top switch. Reach into the grip (3) and guide the pins into their respective locks while pulling down, slide soft top switch (2) forward again.

## **Warning!**

### **The soft top is not locked:**

- **if the indicator lamp in the soft top switch does not go out (key in steering lock position 2),**
- **if the indicator lamp blinks when starting to drive and an audible warning sounds simultaneously.**

**Stop the vehicle and before continuing to drive, lock the soft top:**

**The key should be in steering lock position 2.**

**Slide soft top switch forward. If the soft top is not locked, it may fold back or forward when driving. During soft top operation, do not place your hands near the soft top frame, upper windshield area or soft top storage compartment. Serious personal injury may occur.**

For safety reasons, the soft top cannot be unlocked while driving.

However, if the soft top is not completely locked, it can be locked while driving by pushing the soft/hardtop switch forward.

If the indicator lamp in the soft top switch blinks while activating the switch,

- the battery voltage may be insufficient - start engine and let run while activating switch,
- the system may be overloaded (for example after lowering or raising the soft top approx. 5 consecutive times) - after approx. 2 minutes the soft top switch may be activated again.

If the indicator lamp continues to blink, lock the soft top manually. See Index.

Have the system checked at your authorized Mercedes-Benz dealer as soon as possible.

Note:

If the roll bar was raised automatically, the process of raising or lowering the soft top will take somewhat longer, as the roll bar must first be lowered.

Whenever possible, park vehicle in the shade as continuous exposure to sun rays can prematurely deteriorate the soft top material.

The soft top may become moldy if it is kept in the storage compartment for an extended period.

Therefore, we recommend raising and airing it thoroughly with the side windows open (do not expose it to the sun) at regular intervals during the wet and cold seasons.

## Wind Screen

### Installation

1. Raise roll bar partially using switch on center console.
2. Insert screen into roll bar by positioning hook at bottom of roll bar, on one side, then push the opposite side in place.

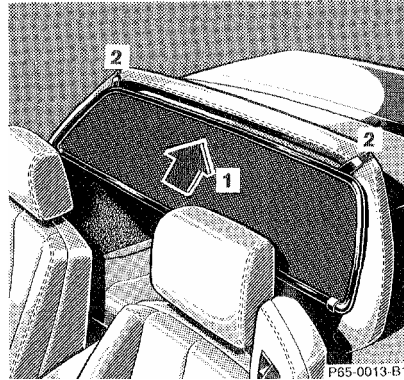

3. Slide wind screen up into roll bar (1), using care not to get the attachment straps (2) caught.

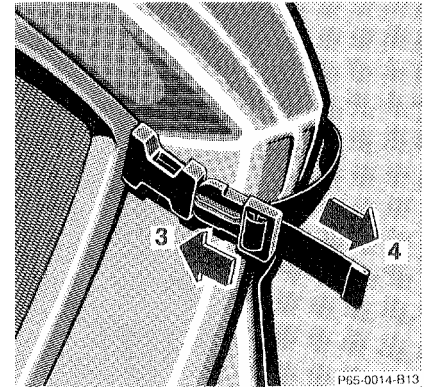

4. Raise roll bar completely.
5. Wrap attachment straps around roll bar and insert tabs into latches (3).
6. Tighten straps (4).
7. Lower roll bar.

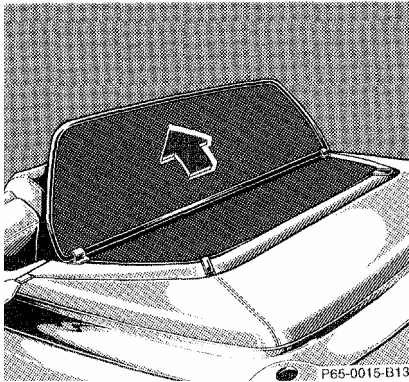

### Setting up

Push top of wind screen fully forward against internal stop

### Warning!

**The rear storage area should never be occupied by passengers since the vehicle is a 2 seater. Furthermore, with the wind screen in place there is a risk of injury, should the roll bar be deployed.**

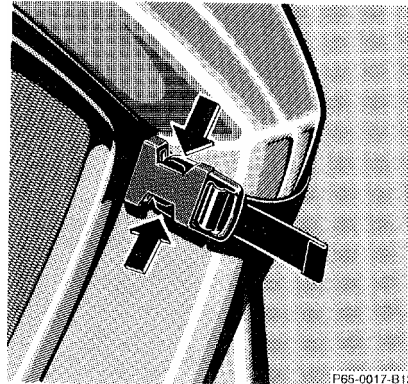

### Removal

1. Fold down top of wind screen.
2. Raise roll bar using switch on center console.
3. Disconnect attachment strap latches by squeezing latch.
4. Lower roll bar partially

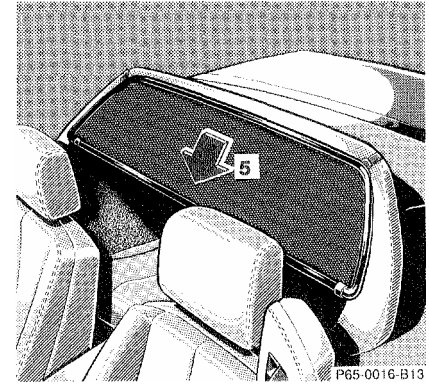

5. Pull wind screen down out of roll bar (5) and lift wind screen out on one side and remove.

### Storage

The wind screen can be stored in a trunk mounted container.

## **Antenna**

The antenna extends when switching on the radio and/or telephone.

Note:

To retract the antenna (e.g. when entering a car wash) both radio and telephone must be switched off.

## **Cellular Telephone**

The vehicle is prepared for the installation of a cellular telephone. For further information and installation contact your authorized Mercedes-Benz dealer.

## **Warning!**

**Some jurisdictions prohibit the driver from using a cellular telephone while driving a vehicle. Therefore, for safety reasons, the driver should not use the cellular telephone while the vehicle is in motion. Stop the vehicle in a safe location before answering or placing a call.**

**Driving**



## Drinking and Driving

### Warning!

**Drinking and driving can be a very dangerous combination. Even a small amount of alcohol or drugs can affect your reflexes, perceptions and judgment. The possibility of a serious or even fatal accident is sharply increased when you drink and drive. Please don't drink and drive or allow a friend to drive when he has been drinking.**

## Engine Oil Pressure Gauge

The oil pressure at idle speed may drop if the engine is at operating temperature. This will not jeopardize the engine's operational reliability. Pressure must, however, rise immediately upon acceleration.

### Note:

If the oil pressure gauge needle drops to "0" with the engine running, then damage to the engine may occur with continued operation. Turn off engine immediately and contact an authorized Mercedes-Benz dealer. Do not operate the car until the condition is repaired.

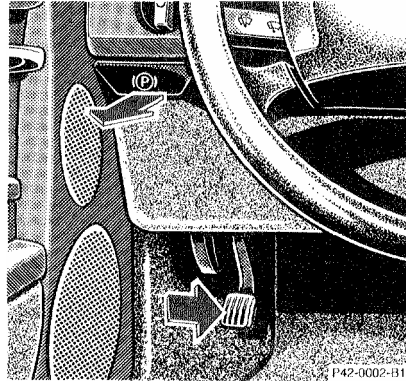

## Parking Brake

To engage, depress parking brake pedal. With the key in steering lock position 2, the brake warning lamp in the instrument cluster should come on brightly (function check for lamp). To release the parking brake, pull handle on instrument panel. The brake warning lamp in the instrument cluster should go out (also see brake warning lamp, page 88).

## Driving Off

Test the brakes briefly after driving off. Perform this procedure only when the road is clear of other traffic. Warm up the engine smoothly. Do not place full load on the engine until the operating temperature has been reached.

## Tachometer

Red marking on tachometer:  
Excessive engine speed.

Avoid this engine speed, as it may result in engine damage that is not covered by the Mercedes-Benz Limited Warranty.

For engine protection, the fuel supply is interrupted if the engine is operated within the red marking.

### Warning!

**Keep driver's foot area clear at all times. Objects stored in this area may impair pedal movement.**

## Automatic Transmission

The automatic transmission selects individual gears automatically, dependent upon

- Selector lever position
- Accelerator position
- Vehicle speed

### Important!

When parking the car and before working on the vehicle with the engine running, firmly depress the parking brake pedal and shift the selector lever into "P".

### Driving

The selector lever is automatically locked while in position "P". To move the selector lever out of position "P", the service brake pedal must be firmly depressed before the shift lock will release.

Shift selector lever to the desired position only when the engine is idling normally and the service brake is applied. Do not release the brake until ready to drive. The vehicle may otherwise start creeping when the selector lever is in drive or reverse position.

### Warning!

**It is dangerous to shift the selector lever out of "P" or "N" if the engine speed is higher than idle speed. If your foot is not on the brake pedal, the car could accelerate quickly forward or in reverse. You could lose control of the car and hit someone or something. Only shift into gear when the engine is idling normally and when your right foot is firmly on the brake pedal.**

### Important!

After selecting any driving position from "N" or "P", wait a moment to allow the gear to fully engage before accelerating, especially when the engine is cold.

## Accelerator position

Partial throttle = early upshifting = normal acceleration

Full throttle = later upshifting = rapid acceleration

Kickdown (depressing the accelerator beyond full throttle) = downshifting to next lowest gear = maximum acceleration. Once the desired speed is attained, ease up on the accelerator - the transmission shifts up again.

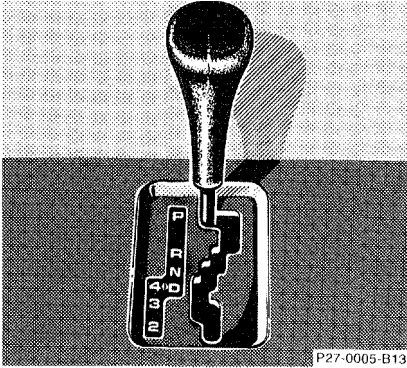

### Selector Lever Positions SL 320

The automatic gear shifting process can be adapted to specific operating conditions using the selector lever.

#### **P** Parking lock.

The parking lock is an additional safeguard to the parking brake when parking the vehicle. Engage only with the car stopped.

Note:

The key can be removed from the steering lock only with the selector lever in position "P". With the key removed, the selector lever is locked in position "P".

#### **R** Reverse gear.

Shift to reverse gear only with the car stopped.

#### **N** Neutral.

No power is transmitted from the engine to the rear axle. When the brakes are released, the vehicle can be moved freely (pushed or towed). Do not engage "N" while driving except to coast when the vehicle is in danger of skidding (e.g. on icy roads, see page 19).

### **Important!**

Coasting the vehicle for an extended period of time with selector lever in "N" can result in transmission damage. That is not covered by the MERCEDES-BENZ Limited Warranty.

**D** The transmission automatically upshifts to 5th gear. Position "D" provides optimum driving characteristics under all normal operating conditions.

**3** Upshift to 4th gear only.  
Suitable for performance driving.

**4** Upshift to 3rd gear only. Suitable for moderately steep hills. Since the transmission does not shift higher than 3rd gear, this gear selection will allow use of the engine's braking power downhill.

**2** Upshift to 2nd gear only. For driving in mountainous regions or under extreme operating conditions. This gear selection will allow use of the engine's braking power when descending steep grades.

### **Important!**

With selector lever in position "D", "4" or "3", upshifting from 1st to 2nd to 3rd gear is delayed depending on vehicle speed and engine temperature. This allows the catalytic converter to heat up more quickly to operating temperatures. During the brief warm-up period this delayed upshift and increased engine noise might be perceived as a malfunction. However, neither the engine nor transmission are negatively affected by this mode of operation.

### **Important!**

The delayed upshift is effective with vehicle speeds below 31 mph (50 km/h) at partial throttle and engine temperatures below 95°F (35°C).

Do not exceed the vehicle speed limits for individual gear selections, which are indicated by marks (I, II, III, etc.) on the circumference of the speedometer.

To avoid over-revving the engine, the selector lever cannot be moved to a lower gear if the vehicle speed exceeds the speed limit of that gear.

### **Warning!**

**On slippery road surfaces, never downshift in order to obtain braking action. This could result in rear wheel slip and reduced vehicle control. Your vehicle's ABS will not prevent this type of loss of control.**

To prevent the engine from laboring at low RPMs, do not allow the engine speed to drop too low on uphill gradients.

Depending on the degree of the incline, shift selector lever to a lower gear early enough to maintain engine RPM within the best torque range.

### **Stopping**

For brief stops, e.g. at traffic lights, leave the transmission in gear and hold vehicle with the service brake. For longer stops with the engine idling, shift into "N" or "P".

When stopping the car on an uphill incline, do not hold it with the accelerator, use the brake. This avoids unnecessary transmission heat build up.

### **Maneuvering**

To maneuver in tight areas, e.g. when pulling into parking space, control the car speed by gradually releasing the brakes. Accelerate gently and never abruptly step on the accelerator.

To rock a car out of soft ground (mud or snow), alternately shift from forward to reverse, while applying slight partial throttle.

Rocking a car free in this manner may cause the ABS warning lamp to come on. Turn off and restart the engine to clear the malfunction indication.

### **Warning!**

**Getting out of your car with the selector lever not fully engaged in position "P" is dangerous. When parked on a steep incline, position "P" alone may not prevent your vehicle from rolling, possibly hitting people or objects.**

**Always set the parking brake in addition to shifting to position "P". When parked on an incline, also turn front wheel against curb.**

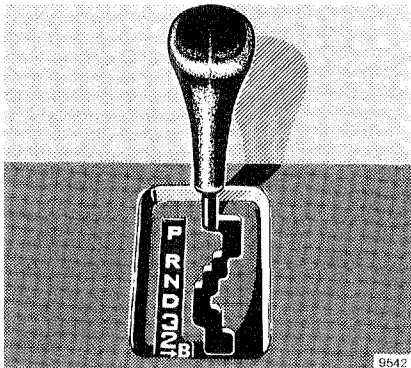

### Selector Lever Positions 500 SL, 600 SL

The automatic gear shifting process can be adapted to specific operating conditions using the selector lever.

- P** Parking lock.  
The parking lock is an additional safeguard to the parking brake when parking the vehicle. Engage only with the car stopped.

Note:

The key can be removed from the steering lock only with the selector lever in position "P". With the key removed, the selector lever is locked in position "P".

- R** Reverse gear.  
Shift to reverse gear only with the car stopped.
- N** Neutral.  
No power is transmitted from the engine to the rear axle. When the brakes are released, the vehicle can be moved freely (pushed or towed). Do not engage "N" while driving except to coast when the vehicle is in danger of skidding (e.g. on icy roads, see page 19).

#### **Important!**

Coasting the vehicle for an extended period of time with selector lever in "N" can result in transmission damage. That is not covered by the MERCEDES-BENZ Limited Warranty.

- D** The transmission automatically upshifts to 4th gear. Position "D" provides optimum driving characteristics under all normal operating conditions.

- 3** Upshift to 3rd gear only. Suitable for moderately steep hills.
- 2** Upshift to 2nd gear only. For driving in mountainous regions. Since the transmission does not shift higher than 2nd gear, this gear selection will allow use of the engine's braking power downhill.
- B** In this position, the engine's braking effect is utilized by shifting into 1st gear. Use this position while descending very steep or lengthy downgrades and only at speeds below 40 mph (60 km/h).

#### **Important!**

With selector lever in position "D" or "3", upshifting from 2nd to 3rd gear is delayed depending on vehicle speed and engine temperature. This allows the catalytic converter to heat up more quickly to operating temperatures. During the brief warm-up period this delayed upshift and increased engine noise might be perceived as malfunction. However, neither the engine nor transmission are negatively affected by this mode of operation.

The delayed upshift is effective with vehicle speeds below 31 mph (50 km/h) at partial throttle and engine temperatures below 95°F(35°C).

### **Important!**

Do not exceed the vehicle speed limits for individual gear selections, which are indicated by marks (I, II, III etc.) on the circumference of the speedometer.

Do not brake the vehicle by downshifting to a lower gear (for example from "D" to "3") unless the speedometer needle is below the speed limit mark of that particular gear range. Overrevving could result in serious damage to the engine.

### **Warning!**

**On slippery road surfaces, never downshift in order to obtain braking action. This could result in rear wheel slip and reduced vehicle control Your vehicle's ABS will not prevent this type of loss of control. This applies particularly for position "B".**

To prevent the engine from laboring at low RPMs, do not allow the engine speed to drop too low on uphill gradients.

Depending on the degree of the incline, shift selector lever to a lower gear range early enough to maintain engine RPM within the best torque range.

### **Maneuvering**

To maneuver in tight areas, e.g. when pulling into parking space, control the car speed by gradually releasing the brakes. Accelerate gently and never abruptly step on the accelerator.

To rock a car out of soft ground (mud or snow), alternately shift from forward to reverse, while applying slight partial throttle.

Rocking a car free in this manner may cause the ABS warning lamp to come on. Turn off and restart the engine to clear the malfunction indication.

### **Stopping**

For brief stops, e.g. at traffic lights, leave the transmission in gear and hold vehicle with the service brake.

For longer stops with the engine idling, shift into "N" or "P".

When stopping the car on an uphill incline, do not hold it with the accelerator, use the brake. This avoids unnecessary transmission heat build up.

### **Warning!**

**Getting out of your car with the selector lever not fully engaged in position "P" is dangerous. When parked on a steep incline, position "P" alone may not prevent your vehicle from moving, possibly hitting people or objects.**

**Always set the parking brake in addition to shifting to position "P". When parked on an incline, also turn front wheel against curb.**

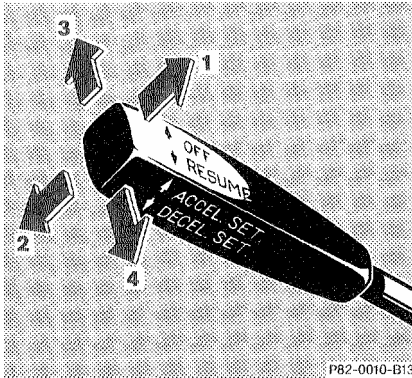

## Cruise Control

Any given speed above approximately 25 mph (40 km/h) can be maintained with the cruise control by operating the lever.

1. Accelerate and set:  
Lift lever briefly to set speed. Hold lever up to accelerate.
2. Decelerate and set:  
Depress lever briefly to set speed.  
Hold lever down to decelerate.

Normally the vehicle is accelerated to the desired speed with the accelerator.

Speed is set by briefly pushing the lever to position 1 or 2. The accelerator can be released.

The speed can be increased (e.g. for passing) by using the accelerator. As "soon as the accelerator is released, the previously set speed will be resumed automatically.

If a set speed is to be increased or decreased slightly, e.g. to adapt to the traffic flow, hold lever in position 1 or 2 until the desired speed is reached, or briefly tip the control lever in the appropriate direction for increases or decreases in 1 km/h (0.6 mph) increments. When the lever is released, the newly set speed remains.

3. Canceling  
To cancel the cruise control, briefly push lever to position 3. When you step on the brake or clutch pedal or the vehicle speed drops below approx. 40 km/h (25 mph), for example when driving upgrade, the cruise control will be canceled.  
If the cruise control cancels by itself and remains inoperative until the engine is restarted, have the system checked at your authorized MERCEDES-BENZ dealer as soon as possible.
4. Resume  
If the lever is briefly pushed to position 4 when driving at a speed exceeding approx. 40 km/h (25 mph), the vehicle resumes the speed which was set prior to the cancellation of the cruise control. The last memorized speed is canceled when the key in the steering lock is turned to position 1 or 0.

Note:

If the engine does not brake the vehicle sufficiently while driving on a downgrade, the speed you set on the cruise control may be exceeded and you may have to step on the brake pedal to slow down. As soon as the grade eases, the cruise controlled speed will again be maintained as long as the brakes were not previously applied, or the lever may be used to resume the previously set speed if the brakes were applied.

**Warning!**

**Only use the cruise control if the traffic and weather conditions make it advisable to travel at a steady speed.**

- **The use of cruise control can be dangerous on winding roads or in heavy traffic because conditions do not allow safe driving at a steady speed.**
- **The use of cruise control can be dangerous on slippery roads. Rapid changes in tire adhesion can result in wheel spin and loss of control.**

**The "Resume" function should only be operated if the driver is fully aware of the previously set speed and wishes to resume this particular preset speed.**

**Caution!**

When driving with the cruise control engaged, the transmission selector lever must not be shifted to position "N" as otherwise the engine will overrev, possibly causing engine damage that is not covered by the Mercedes-Benz Limited Warranty.



## **Charge Indicator Lamp**

Should the charge indicator lamp fail to come on prior to starting when the key is in steering lock position 2 or should it fail to go out after starting or during operation, this indicates a fault which must be repaired at an authorized MERCEDES-BENZ dealer immediately.

If the charge indicator lamp comes on while the engine is running, this may indicate that the poly-V-belt has broken. Should this condition occur, the poly-V-belt must be replaced before continuing to operate the vehicle. Otherwise, the engine will overheat due to an inoperative water pump which may result in damage to the engine.

Do not continue to drive the vehicle with the charge indicator lamp illuminated. Doing so could result in engine damage that is not covered by the Mercedes-Benz Limited Warranty.

## **Engine Oil Pressure Gauge with Oil Pressure Warning Lamp**

With the key in steering lock position 2, the oil pressure warning lamp comes on and goes out with the engine running.

The oil pressure at idle speed may drop if the engine is at operating temperature. This will not jeopardize the engine's operational reliability.

Pressure must, however, rise immediately upon acceleration.

### **Note:**

If the oil pressure warning lamp does not go out after starting the engine or comes on while driving and the oil pressure gauge needle drops to "0", then damage to the engine may occur with continued operation. Turn off engine immediately and contact an authorized MERCEDES-BENZ dealer. Do not operate the car until the condition is repaired.

There is no need for concern should the oil pressure warning lamp light up briefly, (for example, in sharp turns or hard braking) provided the lamp goes out immediately. We recommend you to drive to the nearest service station where the engine oil should be topped to the "full" mark on the dipstick with an approved oil.

## **Low Engine Oil Level Warning Lamp**

With the key in steering lock position 2, the oil pressure warning lamp comes on and goes out with the engine running.

If the warning lamp comes on with the engine running and at operating temperature, the engine oil level has dropped to approximately the minimum mark on the dipstick.

When this occurs, the warning lamp will first come on intermittently and then stay on if the oil level drops further.

If no oil leaks are noted and there is indicated engine oil pressure, continue to drive to the nearest service station where the engine oil should be topped to the "full" mark on the dipstick with an approved oil.

The low engine oil level warning light should not be ignored. Extended driving with the light illuminated could result in engine damage that is not covered by the Mercedes-Benz Limited Warranty.

In addition to the warning lamp, the engine oil level should be periodically checked with the dipstick, for example during a fuel stop, or before a long trip. See page 98.

## **Engine Oil Consumption**

Engine oil consumption checks should only be made after the break-in period. During the break-in period, higher oil consumption may be noticed and is normal. Frequent driving at high engine speeds results in increased consumption.

## **Fuel Consumption Gauge**

While driving, instantaneous fuel consumption is indicated in miles per gallon (mpg), or in Canada liters per 100 kilometers (l/100 km).

With the engine switched off, the needle reads "0".

Due to system design, maximum consumption is indicated at idle speed.

## Fuel Reserve Warning Lamp

With the key in steering lock position 2, the fuel reserve warning lamp comes on and goes out with the engine running.

If the warning lamp does not go out after starting the engine or if it comes on while driving, it indicates that the fuel level is down to the reserve quantity of approx. 2.6 gal (10 liters).

## Outside Temperature Indicator

The temperature sensor is located in the front bumper area. Due to its location, the sensor can be affected by road or engine heat during idling or slow driving. This means that the accuracy of the displayed temperature can only be verified by comparison to a thermometer placed next to the sensor, not by comparison to external displays (e.g. bank signs, etc.).

Adaptation to ambient temperature takes place in steps and depends on the prevailing driving conditions (stop-and-go or moderate, constant driving) and amount of temperature change.

## Warning!

**The outside temperature indicator is not designed to serve as an Ice-Warning Device and is therefore unsuitable for that purpose. Indicated temperatures just above the freezing point do not guarantee that the road surface is free of ice.**

## Coolant Temperature Gauge

If the antifreeze mixture is effective to  $-22^{\circ}\text{F}$  ( $-30^{\circ}\text{C}$ ), the boiling point of the coolant in the pressurized cooling system of your vehicle is approx.  $266^{\circ}\text{F}$  ( $130^{\circ}\text{C}$ ).

During severe operating conditions and stop-and-go city traffic, the coolant temperature may rise close to the red marking.

The engine should not be operated with the coolant temperature in the red zone. Doing so may cause serious engine damage which is not covered by the Mercedes-Benz Limited Warranty.

## Warning!

- **Driving when your engine is badly overheated can cause some fluids which may have leaked into the engine compartment to catch fire. You could be seriously burned. Turn off the engine and get out of the car until it cools down.**
- **Steam from an overheated engine can cause serious burns and can occur just by opening the engine hood. Stay away from the engine if you see or hear steam coming from it. Turn off the engine and do not stand near the car until it cools down.**

### **Low Engine Coolant Level Warning Lamp**

With the key in steering lock position 2, the warning lamp comes on and goes out with the engine running.

If the warning lamp does not go out after starting the engine, or if it comes on while driving, then the coolant level has dropped below the required level. If no leaks are noticeable and the engine temperature does not increase, continue to drive to the nearest service station and have coolant added to the coolant system. (see Index).

The low engine coolant level warning light should not be ignored. Extended driving with the light illuminated may cause serious engine damage not covered by the Mercedes-Benz Limited Warranty.

In cases of major or frequent minor coolant loss, have the cooling system checked at your authorized MERCEDES-BENZ dealer as soon as possible.

Note:

Do not drive without coolant in the cooling system. The engine can overheat causing major engine damage.

Monitor the coolant temperature gauge while driving.

### **Warning!**

**Do not spill antifreeze on hot engine parts. Antifreeze contains ethylene glycol which may burn if it comes into contact with hot engine parts. You can be seriously burned.**

### **Low Windshield and Headlamp Washer Fluid Level Warning Lamp**

With the key in steering lock position 2, the warning lamp comes on and goes out with the engine running.

If the warning lamp comes on with the engine running, the level of the reservoir has dropped to approx. 1/4 of the total volume. The reservoir should be refilled with MB Windshield Washer Concentrate "S" and water (or commercially available premixed windshield washer solvent/antifreeze, depending on ambient temperature - see Index) at the next opportunity. The reservoir for the windshield and headlamp washer system is located in the engine compartment.

## Roll Bar Warning Lamp

With the key in steering lock position 2, the warning lamp comes on and goes out with the engine running.

### Warning!

**If the warning lamp does not go out after starting the engine, or if it comes on while driving, and the indicator lamps in the roll bar switch blink simultaneously, then the roll bar system is defective and may not activate in an accident. In this case, raise the roll bar manually (see Index) before continuing to drive.**

Have the roll bar system checked at your authorized MERCEDES-BENZ dealer as soon as possible.

## Seat Belt and Backrest Lock Warning Lamp

With the key in steering lock position 2, the warning lamp comes on and an audible warning sounds for a short time if the driver's seat belt is not fastened.

If a backrest is not engaged in its lock, an audible warning will sound intermittently for up to approx. 20 seconds.

After starting the engine, the warning lamp blinks for a brief period to remind the driver and passenger to fasten seat belts before driving off.

If the warning lamp does not go out after blinking briefly, but is instead lit continuously, then a backrest is not engaged in its lock.

The warning lamp goes out as soon as the backrest is engaged in its lock.

If the backrest is locked and the warning lamp does not go out, have the system checked at your authorized MERCEDES-BENZ dealer as soon as possible.

## Exterior Lamp Failure Indicator Lamp

With the key in steering lock position 2, a dim indicator lamp comes on and goes out with the engine running.

With the key in steering lock position 2 or with the engine running, a bright illumination of this lamp indicates an exterior lamp failure (except high mounted stop lamp).

### Note:

The indicator lamp will also come on if an incorrect bulb is installed. If additional lighting equipment is installed (e.g. auxiliary headlamps etc.) be certain to connect into the fuse before the failure indicator monitoring unit in order to avoid damaging the system.

If an exterior lamp fails, the indicator lamp will come on only when that lamp is switched on.

If a brake or turn signal lamp fails, the lamp failure indicator will come on when applying the brake or actuating the turn signal and stay on until the engine is turned off.

## Brake Pad Wear Indicator Lamp

The brake pad wear indicator lamp in the instrument cluster comes on when the key in the steering lock is turned to position 2 and goes out when the engine is running.

If the indicator lamp lights up during braking, this indicates that the front wheel brake pads are worn down (vehicles equipped with ASR front and/or rear wheel brake pads).

Have the brake system checked at your authorized MERCEDES-BENZ dealer as soon as possible.

- 

## Brake Warning Lamp

The brake warning lamp will come on:

- when there is insufficient brake fluid in the reservoir (engine running and parking brake released)
- as a lamp function check (key in steering lock position 2).

When the minimum mark on the reservoir is reached, have the brake system checked for brake pad thickness and leaks.

To test the brake warning lamp, turn the key in steering lock to position 2. The brake warning lamp comes on, and should go out when the engine is running.

## Warning!

**Driving with the brake warning lamp on can result in an accident. Have your brake system checked immediately if the brake warning lamp stays on. Don't add brake fluid before checking the brake system. Overfilling the brake fluid reservoir can result in spilling brake fluid on hot engine parts and the brake fluid catching fire. You can be seriously burned.**

## Antilock Brake System (ABS)

The ABS prevents the wheels from locking up above a vehicle speed of approximately 3 km/h (2 mph) independent of road surface conditions. It is necessary, however, that the vehicle speed reaches at least 8 km/h (5 mph) before commencing to brake.

At the instant one of the wheels is about to lock up, a slight pulsation can be felt in the brake pedal, indicating that the ABS is in the regulating mode.

On slippery road surfaces, the ABS will respond even with only slight brake pedal pressure. The pulsating brake pedal can be an indication of hazardous road conditions and functions as a reminder to take extra care while driving.

The ABS warning lamp in the instrument cluster comes on with the key in steering lock position 2 and should go out with the engine running.

If the charging voltage falls below 10 volts, the warning lamp comes on and the ABS is switched off. When the voltage is above this value again, the warning lamp should go out and the ABS will be operational.

If the ABS warning lamp does not go out or comes on while driving, it indicates that the ABS has detected a malfunction and has switched off. In this case, the brake system functions in the usual manner, but without antilock assistance.

Have the system checked at your authorized MERCEDES-BENZ dealer as soon as possible.

## Warning!

**Even the ABS cannot prevent the natural laws of physics from acting on the vehicle. The ABS cannot prevent accidents, including those resulting from excessive speed in turns, following another vehicle too closely, or aquaplaning. Only a safe, attentive, and skillful driver can prevent accidents. The capabilities of an ABS equipped car must never be exploited in a reckless or dangerous manner which could jeopardize the user's safety or the safety of others.**

### Note:

To alert following vehicles to slippery road conditions you discover, operate your hazard warning flashers as appropriate.

## Acceleration Slip Control (ASR)

The acceleration slip control will engage at all vehicle speeds, if one or both drive wheels begin to lose traction and spin due to excessive acceleration. While engaged, the yellow function indicator in the speedometer lights up. With the acceleration slip control engaged, the brake is applied to the spinning drive wheel until it regains sufficient traction. If both drive wheels lose traction and spin, the brake is applied to both drive wheels and simultaneously, engine torque is limited.

As traction on the road surface increases, the allowable engine torque also increases again and the brake is no longer applied to drive wheels.

## Caution!

If the vehicle is towed with the front axle raised (see *Towing the vehicle* in Index), the key must not be in steering lock position 2. Otherwise, the acceleration slip control will immediately be engaged and will apply the rear wheel brakes.

### Notes:

With the key in steering lock position 2, the yellow function indicator lamp and the yellow ASR warning lamp in the instrument cluster come on. They must go out with the engine running.

If the ASR warning lamp comes on with the engine running, a malfunction has been detected. Pressing the accelerator pedal will require greater effort. Only partial engine output is available.

Have the acceleration slip control checked at your authorized Mercedes-Benz dealer as soon as possible.

Driving the vehicle with varied size tires will cause the wheels to rotate at different speeds, therefore the acceleration slip control will activate (yellow ASR function indicator lamp in instrument cluster comes on). For this reason, all wheels, including the spare wheel, must have the same tire size.

When testing the parking brake on a brake test dynamometer, the key must not be in steering lock position 2. Otherwise, the acceleration slip control will immediately be engaged and will apply the rear wheel brakes.

In winter operation, the maximum effectiveness of the acceleration slip control can only be achieved with M + S radial-ply tires recommended by Mercedes-Benz.

On vehicles equipped with acceleration slip control, the brake pad wear warning lamp indicates brake pad wear for the front as well as the rear brakes.



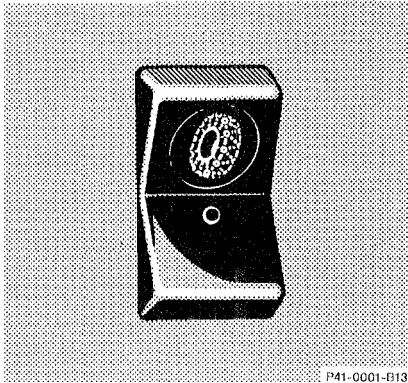

Snow chain switch

### **Driving with Snow Chains**

When driving with snow chains, press the upper half of the snow chain switch, located on the instrument panel (the indicator lamp in the switch comes on).

This mode is effective at speeds up to 40 km/h (25 mph). It re-mains stored in memory up to 60 km/h (37 mph) and automatically engages again when the vehicle speed drops below 40 km/h (25 mph).

This mode is effective at speeds up to 25 mph (40 km/h). It remains stored in memory up to 37 mph (60 km/h) and automatically engages again when the vehicle speed drops below 25 mph (40 km/h).

The mode is canceled in memory above 37 mph (60 km/h) and the indicator lamp in the switch goes out.

To switch off: press lower half of switch (the indicator lamp in the switch goes out).

## Adaptive Damping System (ADS)

Depending upon road surface conditions, load, driving style, ADS will automatically adjust the optimal ride firmness.

The indicator lamp comes on with the key in steering lock position 2 and goes out when the engine is running.

If the indicator lamp stays on after the engine is running or comes on while driving, then the system has detected a malfunction.

We recommend that you visit an authorized Mercedes-Benz dealer as soon as possible to have the system checked-out.

### Note:

If the battery was disconnected, the indicator lamp will only go out after the engine is started and the steering wheel is turned from full left to full right lock and returned to the center position.

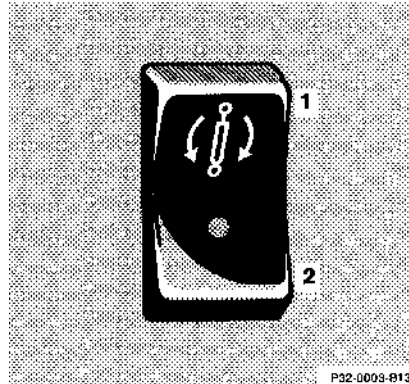

## Adaptive Damping System Adjustment

The switch is located in the center console.

1. Firm dampening program.  
This setting should be used for sporty driving.  
During the setting for sporty driving the indicator lamp in the switch lights up.
2. Soft dampening program.  
This setting should be used for regular driving.

### Note:

The firm dampening program must be selected again when restarting the engine.

## Emission Control

Certain systems of the engine serve to keep the toxic components of the exhaust gases within permissible limits required by law.

These systems, of course, will function properly only when maintained strictly according to factory specifications. Any adjustments on the engine should, therefore, be carried out only by qualified MERCEDES-BENZ technicians. Engine adjustments should not be altered in any way. Moreover, the specified service and maintenance jobs must be carried out regularly according to MERCEDES-BENZ servicing requirements. For details refer to the Maintenance Booklet.

## Warning!

**Inhalation of exhaust gas is hazardous to your health. All exhaust gas contains carbon monoxide, and inhaling it can cause unconsciousness and lead to death. Do not run the engine in confined areas (such as a garage) which are not properly ventilated. If you think that exhaust gas fumes are entering the vehicle while driving, have the cause determined and corrected immediately. If you must drive under these conditions, drive only with at least one window fully open.**

## On-Board Diagnostic System SL 500 (California version only); other models (all states)

The Sequential Multiport Fuel Injection (SFI) control module monitors emission control components that either provide input signals to or receive output signals from the control module. Malfunctions resulting from interruptions or failure of any of these components are indicated by the "CHECK ENGINE" malfunction indicator lamp in the instrument cluster and are simultaneously stored in the SFI control module.

If the "CHECK ENGINE" malfunction indicator lamp comes on, have the system checked at your authorized Mercedes-Benz dealer as soon as possible.

An on-board diagnostic connector allows the accurate identification of system malfunctions through the readout of diagnostic trouble codes.

Connector location:

SL 320 - passenger compartment, near the accelerator pedal. SL 500, SL 600 - engine compartment, on firewall.

## Traveling Abroad

Abroad, there is a widely-spread MERCEDES-BENZ service network at your disposal. If you plan to travel into areas which are not listed in the index of your dealer directory, you should request pertinent information from your authorized MERCEDES-BENZ dealer.

## Winter Driving

Have your car winterized at your authorized MERCEDES-BENZ dealer before the onset of winter.

- Change the engine oil if the engine contains an oil which is not approved for winter operation. For viscosity (SAE class) and filling quantity, see "Fuels, Coolants, Lubricants, etc." see Index.
- Check engine coolant anticorrosion/antifreeze concentration.

- Additive for the windshield washer and headlamp cleaning system: Add MB Concentrate "S" to a premixed windshield washer solvent/antifreeze which is formulated for below freezing temperatures (see Index).
- Test battery: Battery capacity drops with decreasing ambient temperature. A well charged battery ensures that the engine can always be started, even at low ambient temperatures.
- Tires: We recommend M + S radial tires on all four wheels for the winter season. Observe permissible maximum speed for M + S radial tires and the legal speed limit.

### Note:

In winter operation, the maximum efficiency of the acceleration slip control or of the automatic locking differential is only achieved with M + S radial tires.

## Snow Chains

Use only snow chains that are tested and recommended by MERCEDES-BENZ. Your authorized MERCEDES-BENZ dealer will be glad to advise you on this subject.

Chains should only be used on the rear wheels. Follow the manufacturer's mounting instructions.

Snow chains should only be driven on snow covered roads at speeds not to exceed 50 km/h (30 mph). Remove chains as soon as possible when driving on roads without snow.

For tips on driving on slippery winter roads, refer to Index.

Vehicles with Acceleration Slip Control (ASR):

When driving with snow chains, press the snow chain switch, refer to Index.



## **Practical Hints**

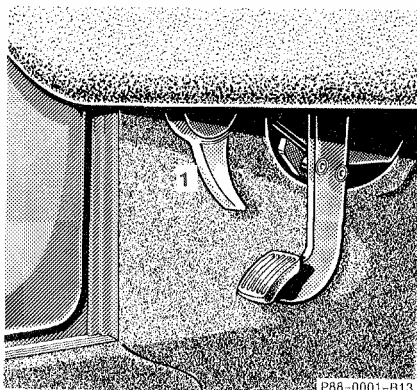

## Hood

To open:

To unlock the hood, pull release lever (1) under the driver's side of the instrument panel.

### Important!

To avoid damage to the windshield wipers or hood, open the hood only with wipers in the parked position.

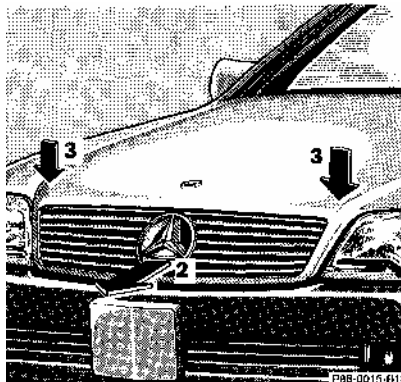

Pull handle (2) out of radiator grill to stop, and open hood. Do not lift hood at louvers of grill! Make certain the windshield wiper arm is not folded forward.

To close:

Lower hood and let it drop into lock from a height of approx. 1 ft (30 cm), assisting with flat hands placed only on edges of hood (3).

To avoid hood damage, if hood is not fully closed, re-open and repeat closing procedure.

### Warning!

To help prevent personal injury, stay clear of moving parts when the hood is open and the engine is running. Be sure the hood is properly closed before driving.

The engine is equipped with a transistorized ignition system. Because of the high voltage it is dangerous to touch any components (ignition coil, distributor, spark plug sockets, ignition cables, diagnostic socket) of the ignition system:

- with the engine running,
- while starting the engine,
- if the ignition is "on" and the engine is turned manually.

We recommend that you do not open the hood, if you see flames or smoke coming from the engine compartment.

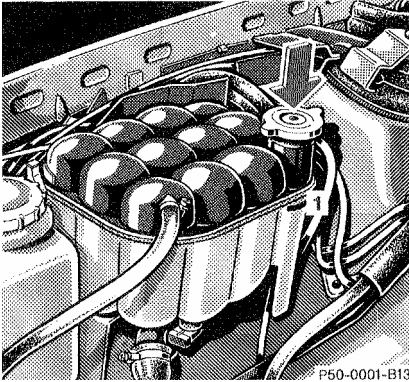

Example

### Checking Coolant Level

The coolant level can be checked visually at the transparent coolant reservoir.

To check the coolant level, the vehicle must be parked on level ground.

Check coolant level only when coolant is cold:

The coolant should reach the rib in the filler neck. Also see marking (1) on reservoir.

### Warning!

- **Use extreme caution when opening the hood if there are any signs of steam or coolant leaking from the cooling system.**
- **Do not remove pressure cap on coolant reservoir if engine temperature is above 90°C (194°F). Allow engine to cool down before removing cap. The coolant reservoir contains hot fluid and is under pressure.**
- **Using a rag, turn cap to first notch to relieve excess pressure. If opened immediately, hot scalding fluid and steam will be blown out under pressure, possibly causing personal injury,**
- **Do not spill antifreeze on hot engine parts. Antifreeze contains ethylene glycol which may burn if it comes into contact with hot engine parts. You can be seriously burned.**

### Adding Coolant

If coolant has to be added, a 50/50 mixture of water and MB anticorrosion/antifreeze should be added.

SL 320:

The drain plugs for the cooling system are located on the right side of the engine block and at the bottom of the radiator.

SL 500, SL 600:

The drain plugs for the cooling system are located on the right and left sides of the engine block and at the bottom of the radiator.

Anticorrosion/antifreeze, see *Coolants* in Index.



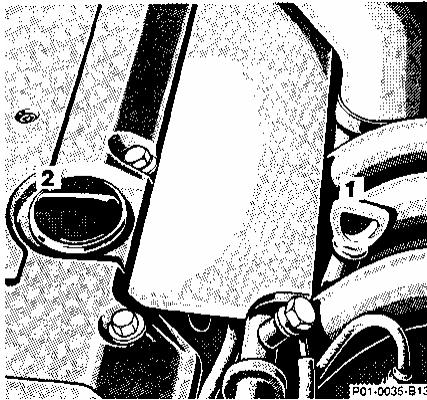

320 SL

### Checking Engine Oil Level

1. Oil dipstick
2. Oil filler cap

To check the engine oil level, park vehicle on level ground, with engine at normal operational temperature.

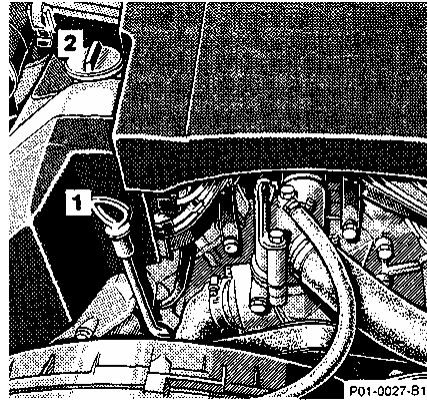

500 SL

The best time to check the engine oil level is when the oil is warm, such as during a fuel stop.

With the vehicle on level ground, stop the engine and wait a few minutes for the oil to drain back to the oil pan.

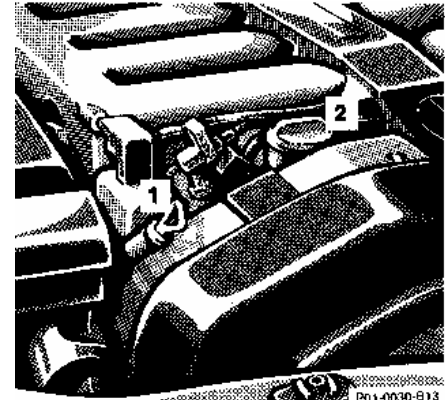

600 SL

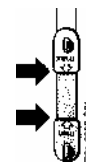

Oil level must be between the lower (min) and upper(max) mark of the dipstick

### Do not overfill engine.

Excessive oil must be drained or siphoned.

For low engine oil level warning lamp, see Index.

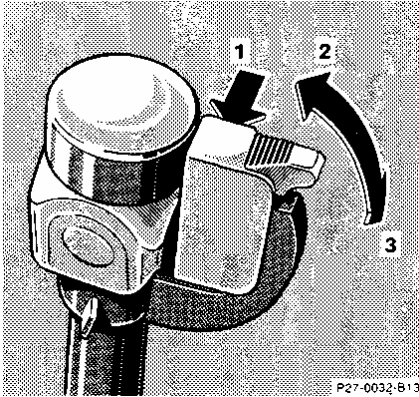

Example

### Checking Automatic Transmission Fluid Level

Dipstick locking lever

1. Break seal
2. Release
3. Engage

Regular automatic transmission fluid level checks are not required. For this reason the dipstick opening is sealed.

When noticing fluid loss or gear shifting malfunctions, we recommend to have your authorized Mercedes-Benz dealer check the transmission fluid level.

The transmission fluid level should only be checked with the engine idling, parking brake engaged and selector lever in position "P". The vehicle must be parked on level ground.

Prior to the check, allow engine to idle for approx. 1 to 2 minutes.

To pull dipstick from tube, break seal by moving plastic pin (1) sideways. Then open cap by releasing locking lever (2).

Measure fluid level with the dipstick completely inserted and the locking lever released (2).

Extreme cleanliness must be observed! To wipe the dipstick, use a clean, lint-free cloth.

To fill the transmission with fluid, pour it through a fine-mesh filter into the dipstick opening. Even the slightest impurity may cause operational troubles.

The level of the transmission fluid is dependent upon its temperature. Two sets of maximum and minimum fluid level marks on the dipstick are applicable references only if the transmission fluid has either reached its normal operating temperature of 176°F (80°C), or its temperature is 86°F (30°C).

### Important!

The fluid level must not exceed the dipstick maximum mark. Drain or siphon excess fluid, if required. Then push dipstick all the way in and swing locking lever downwards (3).

Note:

Damage to transmission caused by contamination of transmission fluid or overfilling of transmission may result in serious transmission damage which is not covered by the Mercedes-Benz Limited Warranty.

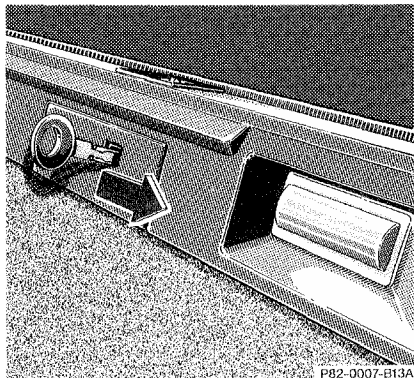

## Trunk Lamp

To switch off: Using car key, slide switch to the left. This prevents the battery from being discharged if the trunk is to remain open for an extended period.

When the trunk lid is closed, the switch will reset and turn on the lamp the next time the lid is opened.

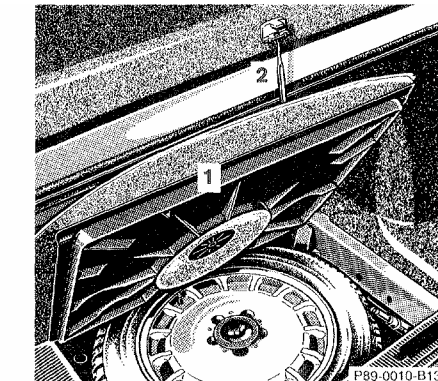

## Spare Wheel

1. Trunk floor
2. Strap

Roll back the floor mat, lift the trunk floor (1) and engage strap (2) in the hooks on the upper edge of the trunk lid.

First remove the vehicle jack, then the spare wheel; reinstall in reverse order.

## First Aid Kit

The first aid kit is located in the left trunk well.

## Stowing Things in the Vehicle

### Warning!

**To help avoid personal injury during a collision or sudden maneuver, exercise care when stowing things. Put luggage or cargo in the trunk if possible. Do not pile luggage or cargo higher than the seat backs.**

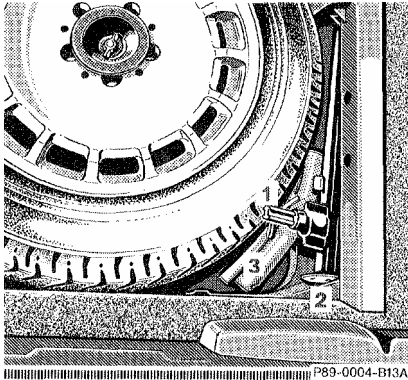

## Vehicle Jack

1. Jack arm
2. Jack base
3. Tool kit

See illustration for proper storage of jack.

Before storing the jack, the jack arm (1) must be lowered almost to the base (2) of the jack.

### Note:

First remove the vehicle jack, then the spare wheel; reinstall in reverse order.

## Warning!

The jack is designed exclusively for jacking up the vehicle at the jack tubes built into either side of the vehicle. Use the jack only to lift the vehicle during a wheel change. Never get beneath the vehicle while it is supported by the jack. Keep hands and feet away from the area under the lifted vehicle. Always firmly set parking brake and block wheels before raising vehicle with jack.

Do not disengage parking brake while the vehicle is raised. Be certain that the jack is always vertical when in use, especially on hills. Lower the vehicle onto sufficient capacity jackstands before working under the vehicle.

## Vehicle Tools

The vehicle tools (3) are located below the jack.

## Wheels

Replace rims or tires with the same designation, manufacturer and type as shown on the original part. See your authorized MERCEDES-BENZ dealer for further information.

## Warning!

Do not mix different tire construction types (i.e. radial, bias, and bias-belted) on your car because handling may be adversely affected and may result in loss of control.

See your authorized MERCEDES-BENZ dealer for information on tested and recommended rims and tires for summer and winter operation. They can also offer advice concerning tire service and purchase.

## Tire Replacement

Front tires should be replaced in sets. Furthermore - in the event of tire replacement - the spare wheel, if possible, should be used on the rear axle. Rims and tires must be of the same size. For dimensions, see "Technical Data".

We recommend that you break in new tires for approx. 100 km (60 miles) at moderate speed. It is imperative that the wheel mounting bolts be retightened after approx. 60 -300 miles (100 to 500 km).

On new vehicles retightening is carried out during the 1st inspection. Retightening is also necessary whenever wheels are fitted, e.g. when the spare wheel is used for the first time or when a set of wheels with M + 8 tires is installed. Tightening torque: 80 ft. lb (110 Nm).

For rim and tire specifications, refer to "Technical Data".

## Warning!

**Worn, old tires can cause accidents. If the tire tread is badly worn, or if the tires have sustained damage, replace them.**

**When replacing rims, use only genuine MERCEDES-BENZ wheel bolts (identified by Mercedes star) specified for the rim type. Failure to do so can result in the bolts loosening and possibly an accident**

## Rotating Wheels

The wheels can be rotated according to the degree of tire wear while retaining the same direction of travel.

Rotating, however, should be carried out at a mileage of 3000-6000 miles (5000-10000) km, before the characteristic tire wear pattern (shoulder wear on front wheels and tread center wear on rear wheels) becomes visible, as otherwise the driving properties deteriorate.

## Important!

Unidirectional snow tires must always be mounted with arrow on tire sidewall pointing in direction of vehicle forward movement.

Note:

Thoroughly clean the inner side of the wheels any time you rotate the wheels or wash the vehicle underside.

The use of retread tires is not recommended. Retread tires may adversely affect the handling characteristics and safety of the vehicle.

Dented or bent rims cause tire pressure loss and damage to the tire beads. For this reason, check rims for damage at regular intervals.

The rim flanges must be checked for wear before a tire is mounted. Remove burrs, if any.

## Warning!

The jack is designed exclusively for jacking up the vehicle at the jack tubes built into either side of the vehicle. Use the jack only to lift the vehicle during a wheel change. Never get beneath the vehicle while it is supported by the jack. Keep hands and feet away from the area under the lifted vehicle. Always firmly set parking brake and block wheels before raising vehicle with jack.

Do not disengage parking brake while the vehicle is raised. Be certain that the jack is always vertical when in use, especially on hills. Lower the vehicle onto sufficient capacity jackstands before working under the vehicle.

## Changing Wheels

Move vehicle to a level area which is a safe distance from the roadway.

1. Set parking brake and turn on hazard warning flasher.
2. Select 1st or reverse gear in vehicles with manual transmission or position "P" in vehicles equipped with automatic transmission.
3. Prevent vehicle from rolling away by blocking wheels with wheel chocks or sizable wood block or stone (not supplied with, vehicle). When changing a wheel on a hill, place chocks on the downhill side blocking both wheels of the other axle. On a level road, place one chock in front of and one behind the wheel that is diagonally opposite to the wheel being changed.

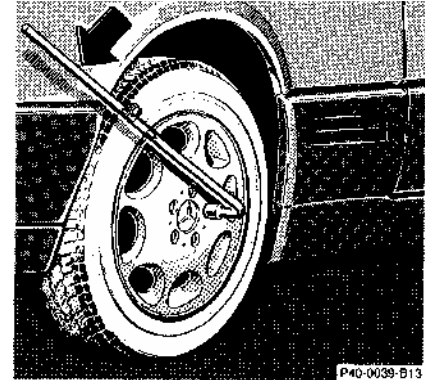

4. Unfold wrench, loosen but do not remove the wheel bolts yet.

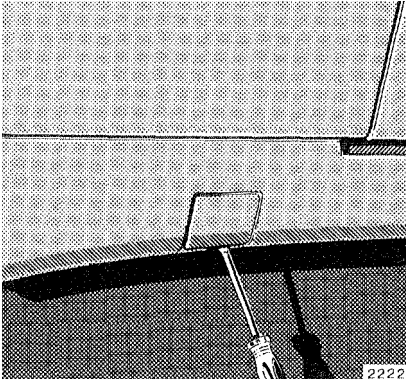

5. Remove the protective cover from the jack support tube opening by inserting a screwdriver in the opening and prying it out.

The tube openings are located directly behind the front wheel housings and in front of the rear wheel housings.

6. Insert jack arm fully into the tube hole up to the stop. Position the jack so that it is always vertical (plumb-line) as seen from the side (see arrow), even if the vehicle is parked on an incline.

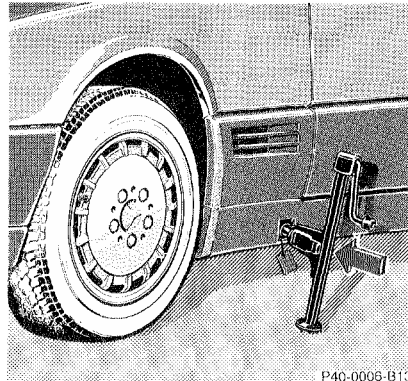

7. Jack up the vehicle until the wheel is clear of the ground.
8. Unscrew wheel bolts completely. Keep bolt threads protected from dirt and sand. While removing the last bolt, hold wheel against hub to avoid paint damage on rim.
9. Remove wheel. Grip wheel from sides. Keep hands from beneath the wheels.

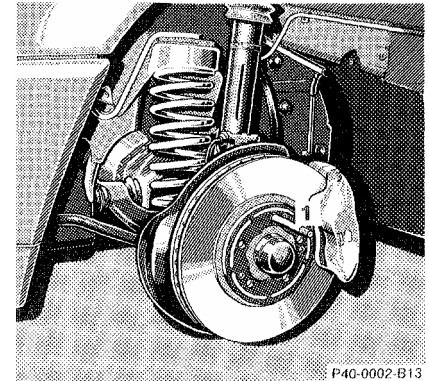

10. Screw the alignment bolt (1) supplied in the tool kit into the upper-most threaded hole.

### **Warning!**

**Always replace wheel bolts that are damaged or rusted.  
Never apply oil or grease to wheel bolts threads.  
Damaged wheel hub threads should be repaired immediately.**

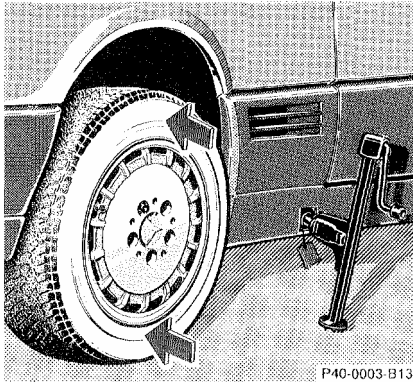

11. Install spare wheel on wheel hub. Insert wheel bolts and tighten them slightly. To avoid paint damage, place wheel flat against hub and hold it there while installing first wheel bolt. Unscrew the alignment bolt to install the last wheel bolt.
12. Lower car. Remove jack and insert jack tube cover.

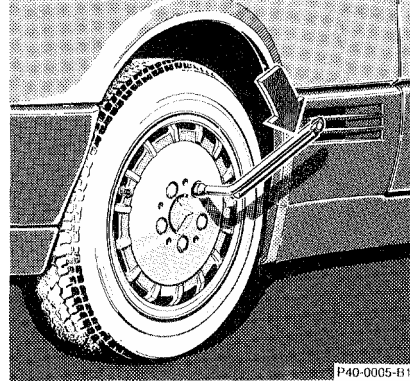

13. Fold wrench together and tighten the five bolts evenly, following the sequence illustrated above, until all bolts are tight. Observe a tightening torque of 80 ft. lb (110 Nm).
14. Correct tire pressure.

**Important!**

When installing new wheels the mounting bolts must be retightened after approx. 60 - 300 miles (100 to 500 km).

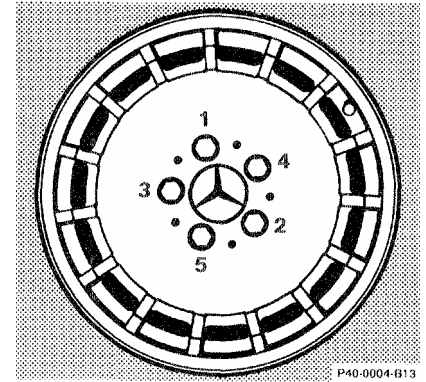

Before storing the jack, the jack arm must be lowered almost to the base of the jack. Store the spare wheel first and then the vehicle jack.

**Warning!**

**Incorrect mounting bolts or improperly tightened mounting bolts can cause the wheel to come off. This could cause an accident. Be sure to use the correct mounting bolts.**



## Tire Inflation Pressure

A table (see fuel filler flap) lists the tire inflation pressures specified for Mercedes Benz recommended tires as well as for the varying operating conditions.

### Important!

Tire pressure differs by approx. 1.5 psi (0.1 bar) per 18°F (10°C) of air temperature change. Keep this in mind when checking tire pressure inside a garage - especially in the winter.

Example:

If garage temperature = approx. + 68 ° F (+ 20 ° C) and ambient temperature = approx. + 32° F (0°C) then the adjusted air pressure = specified air pressure + 3 psi (+ 0.2 bar).

Tire pressures listed for light loads are minimum values offering high driving comfort.

Increased inflation pressures for heavy loads produce favorable handling characteristics with lighter loads and are perfectly permissible. The ride of the vehicle, however, will become somewhat harder.

Tire temperature and pressure increase with the vehicle speed. Tire pressure should therefore only be corrected on cold tires. Correct tire pressure in warm tires only if pressure has dropped below the pressure listed in the table and the respective operating conditions are taken into consideration.

An underinflated tire due to a slow leak (e.g. due to a nail in the tire) may cause damage such as tread separation, bulging etc.. Regular tire pressure checks (including the spare tire) at intervals of no more than 14 days are therefore essential.

If a tire constantly loses air, it should be inspected for damage.

### Warning!

**Do not overinflate tires, overinflating tires can result in sudden deflation (blowout) because they are more likely to become punctured or damaged by road debris, potholes etc.. Follow recommended inflation pressures.**

**Do not overload the tires by exceeding the specified vehicle capacity weight (as indicated by the label on the driver's door latch post). Overloading the tires can overheat them, possibly causing a blowout.**

## Battery

The maintenance-free battery is located in the trunk behind the right-hand cover panel.

The service life of the battery is dependent on its condition of charge. The battery should always **be kept** sufficiently charged **in order** to last an optimum length of time.

**Therefore, we strongly recommend that you have the battery charge checked frequently, and corrected if necessary, especially if you use the vehicle less than approximately 200 miles (300 km) per month, mostly for short distance trips, or if it is not used for long periods of time.**

Only charge a battery with a battery charger after it has been disconnected from the vehicle electrical circuit.

When removing and connecting the battery, always make sure that all electrical consumers are off and the key is in steering lock position 0.

While the engine is running the battery terminal clamps must not be loosened or detached, otherwise the alternator and other electronic components would be damaged.

### Battery Recycling

Batteries contain materials that can harm the environment with improper disposal.

Large 12 Volt storage batteries contain lead, and smaller watch-type batteries (such as in the Infrared Remote Control Unit) may contain mercury.

Recycling of batteries is the preferred method of disposal.

Many states require sellers of batteries to accept old batteries for recycling.

## Warning!

**Never lean over batteries while connecting or jump starting, you might get injured.**

**Battery fluid contains sulfuric acid. Do not allow this fluid to come in contact with eyes, skin or clothing. In case it does, immediately flush affected area with water and seek medical help.**

**A battery will also produce hydrogen gas, which is flammable and explosive. Keep flames or sparks away from battery, avoid improper connection of jumper cables, smoking, etc..**

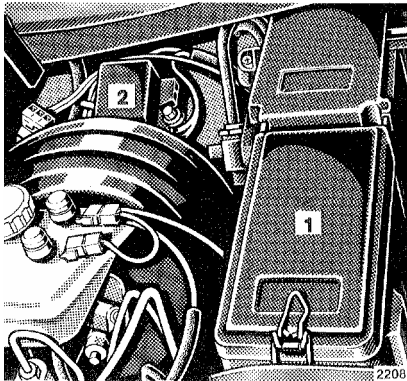

## Fuses

In engine compartment:

1. Main fuse box
2. Auxiliary fuse box

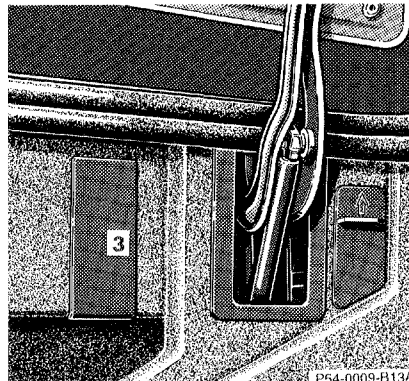

In trunk on rear wall:

3. Auxiliary fuse box

Before replacing a blown fuse, determine the cause of the short circuit.

Spare fuses are supplied inside the fuse box. Observe amperage and color of fuse.

Always use a new fuse for replacement. Never attempt to repair or bridge a blown fuse.

After replacing a blown fuse, close fuse box cover.

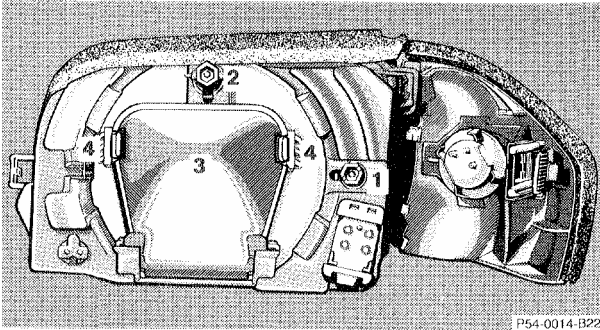

P54-0014-B22

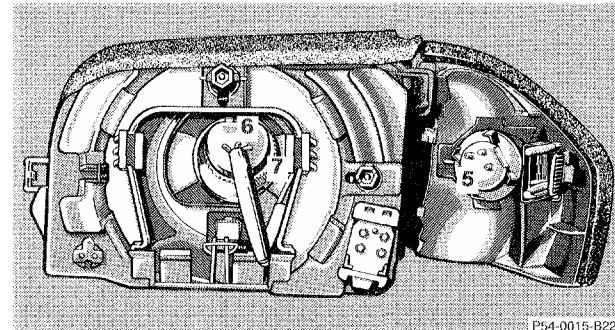

P54-0015-B22

## Exterior Lamps

### Headlamp Adjustment

Correct headlamp adjustment is extremely important. Check and readjust headlamps at regular intervals and when a bulb has been replaced.

### Replacing Bulbs

Do not touch glass portion of bulb with bare hands. Use plain paper or a clean cloth.

Install only 12 volt bulbs with the specified watt rating.

### Headlamp Assembly

1. Headlamp horizontal adjustment screw
2. Headlamp vertical adjustment screw
3. High and low beam headlamp cover
4. Squeeze latches for high and low beam headlamp cover
5. Turn signal, parking, side marker and standing lamp bulb

6. Electrical connector for high and low beam headlamp bulb
7. Clamping ring for high and low beam headlamp bulb

### Warning!

**Halogen lamps contain pressurized gas. A bulb can explode if you:**

- **Touch or move it when hot**
- **Drop the bulb.**
- **Scratch the bulb**

## Replacing bulbs:

Bulb for turn signal, parking, side marker and standing lamp' (21/5 W/32/3cp):

Turn bulb socket (5) with bulb counterclockwise and pull out. Push bulb into socket, turn counterclockwise and remove.

Bulb for high and low beam (Halogen type 9004):

Squeeze latches (4) and remove cover (3) upwards. Pull off electrical connector (6). Turn clamping ring (7) counterclockwise and pull out bulb together with clamping ring. Remove bulb.

Insert new bulb (flat side facing up), mount clamping ring (7) (with tab facing down) and turn clock-wise. Push electrical connector on securely.

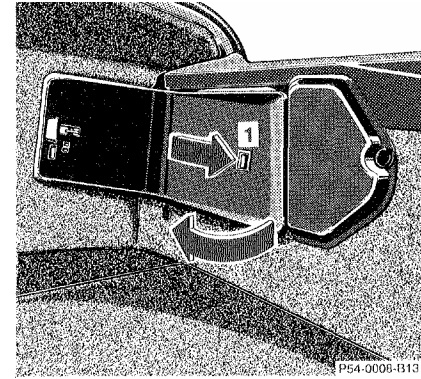
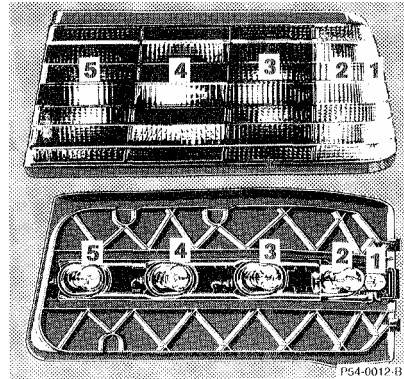

## Taillamp Assemblies

1. Side marker lamp (10 W/6 cp bulb)
2. Turn signal lamp (21/4 W/35/1.2 cp bulb)
3. Tail, parking and standing lamp (21 W/32 cp bulb)

Driver's side:

- Tail, parking, standing and rear fog lamp (21/4W/35/1.2cp bulb)
4. Backup lamp (21 W/32 cp bulb)
5. Stop lamp (21 W/32 cp bulb)

To replace bulbs:

Push the locking button (1) on the rear of the lamp support inward and swing open lamp support. Push down the bulb to be changed, turn to the left and remove.

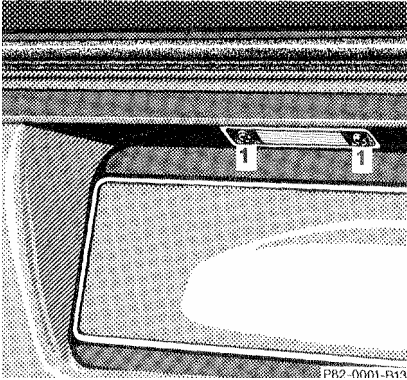

### License Plate Lamps (5 W bulb)

Loosen both securing screws (1),  
remove lamp and take out bulb.

### Jump Starting

If the battery is discharged, the engine can be started with jumper cables and the (12V) battery of another vehicle. The battery is located in the trunk behind the right-hand cover panel. Follow these steps exactly to avoid injury:

#### Warning!

**Failure to follow these directions can lead to a battery explosion and personal injury. Read, all instructions before proceeding.**

Proceed as follows:

1. Position the vehicle with the charged battery so that the jumper cables will reach, but never let the vehicles touch. Make sure the jumper cables do not have loose or missing insulation.

2. On both vehicles:
  - Turn off engine and all lights and accessories, except hazard flashers or work lights.
  - Apply parking brake and shift selector lever to position "P" (neutral for manual transmission).

#### Important!

3. Clamp one end of the first jumper cable to the positive (+) terminal of the discharged battery and the other end to the positive (+) terminal of the charged battery. Make sure the cable clamps do not touch any other metal parts.
4. Clamp one end of the second jumper cable to the grounded negative (-) terminal of the charged battery and the final connection to a grounded heavy metal bracket in the engine compartment or on the engine of the disabled vehicle. Make sure the cables are not on or near pulleys, fans, or other parts that will move when the vehicle with the charged battery is started.

### **Important!**

5. Start engine of the vehicle with the charged battery and run at high idle. Then start engine of the disabled vehicle in the usual manner.
6. After the engine has started, remove jumper cables by reversing the above installation sequence exactly, starting with the jumper cable connected to a heavy metal bracket in the disabled vehicle's engine compartment. When removing each clamp, make sure that it does not touch any other metal while the other end is still attached.

### **Warning!**

**Never lean over batteries while connecting or jump starting, you might get injured.**

**Battery fluid contains sulfuric acid. Do not allow this fluid to come in contact with eyes, skin or clothing. In case it does, immediately flush affected area with water, and seek medical help.**

**A battery will also produce hydrogen gas, which is flammable and very explosive. Keep flames or sparks away from battery, avoid improper connection of jumper cables, smoking, etc..**

### **Important!**

A discharged battery can freeze at approx. + 14°F (-10°C). In that case, it must be thawed out before jumper cables are used.

Jumper cable specifications:

- Minimum cable cross-section of 25 mm<sup>2</sup> or approx. 2 AWG
- Maximum length of 11.5 ft (3.5 m).

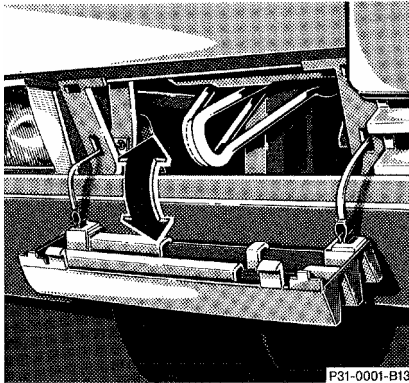

## Towing of Vehicle

The rear towing eye is located at the right, below the bumper. The front towing eye is located on the passenger side behind a flap in the bumper panel.

Flap removal: Insert finger in recess of flap and pull flap out.

Flap installation: Engage flap at bottom and press in top securely.

We recommend that the vehicle be transported using flat bed equipment. This method is preferable to other types of towing.

The vehicle may be towed with all of the wheels on the ground and the selector lever in position "N" for distances up to 30 miles (50 km) and at a speed not to exceed 30 mph (50 km/h).

To positively avoid a possibility of damage to the transmission, however, we recommend to disconnect the drive shaft at the rear axle drive flange on any towing beyond a short tow to a nearby garage.

Do not tow with sling-type equipment. Towing with sling-type equipment over bumpy roads will damage radiator and supports.

The use of wheel lift equipment will damage engine oil pan.

## Important!

When transporting vehicle on flat bed equipment, the front end of the vehicle must be loaded first. Additional ramping may be required for loading to protect bumper fascia.

## Warning!

**With the engine not running, there is no power assistance for the braking and steering systems. In this case, it is important to keep in mind that a considerably higher degree of effort is necessary to brake and steer the vehicle.**

## Note:

To signal turns while being towed with hazard flasher in use, turn key in steering lock to position 2 and activate combination switch for left or right turn signal in usual manner - only the selected turn signal.

Upon canceling the turn signal, all four turn signals will operate again.



## Cleaning and Care of the Vehicle

### Warning!

**Many cleaning products can be hazardous. Some are poisonous, others are flammable. Always follow the instructions on the particular container. Always open your car's doors or windows when cleaning the inside.**

**Never use fluids or solvents that are not designed for cleaning your car.**

In operation, your vehicle is subjected to varying external influences which, if gone unchecked, can attack the paint-work as well as the underbody and cause lasting damage.

Such damage is caused not only by extreme and varying climatic conditions, but also by air pollution, road salt, tar, gravel and stone chipping. Grease and oil, fuel, coolant, brake fluid, bird droppings, tree resins, etc. should be removed immediately to

avoid paint damage. Frequent washing, however, reduces and/or eliminates the aggressiveness and potency of the above adverse influences.

More frequent washings are necessary to deal with unfavorable conditions; for example, near the ocean, in industrial areas (smoke, exhaust emissions), or during winter operation.

You should check your vehicle from time to time for stone chipping or other damage. Any damage should be repaired as soon as possible to prevent the start of corrosion.

In doing so, do not neglect the underside of the car. A prerequisite for a thorough check is a washing of the underbody followed by a thorough inspection. Damaged areas need to be reundercoated.

Your vehicle has been treated at the factory with a wax-base rustproofing in the body cavities which will last for the lifetime of the vehicle. Post-production treatment is neither

necessary nor recommended by MERCEDES-BENZ because of the possibility of incompatibility between materials used in the production process and others applied later.

We have selected car-care products and compiled recommendations which are specially matched to our vehicles and which always reflect the latest technology. You can obtain MB car-care products at your authorized MERCEDES-BENZ dealer.

Scratches, corrosive deposits, corrosion or damage due to negligent or incorrect care cannot always be removed or repaired with the car-care products recommended here. In such cases it is best to seek aid at your authorized MERCEDES-BENZ dealer.

The following topics deal with the cleaning and care of your vehicle and give important "how-to" information as well as references to recommended MB car-care products.

## Engine Cleaning

Corrosion protection, such as MB Anticorrosion Wax should be applied to the engine compartment after every engine cleaning. Before applying, all control linkage bushing should be lubricated. The V-belt and all pulleys should be protected from any wax.

## Car Washing

Before washing your vehicle, remove insect residues, MB Insect Remover is recommended. Do not use hot water or wash your car in direct sunlight. Use only a mild car wash detergent, such as MB Autoshampoo.

Thoroughly spray the car with a diffused jet of water. Direct only a very weak spray towards the ventilation intake. Use plenty of water and rinse the sponge and chamois frequently.

Rinse with clear water and thoroughly wipe dry with a chamois. Do not allow cleaning agents to dry on the finish.

If the vehicle has been run through an automatic car wash - in particular one of the older installations - rewipe the recessed sections in the taillamps (designed to prevent soiling) if necessary. No solvents (fuels, thinners etc.) must be used.

In the winter, thoroughly remove all traces of road salt as soon as possible.

When washing the underbody, do not forget to clean the inner sides of the wheels.

## Tar Stains

Quickly remove tar stains before they dry and become more difficult to remove. MB Tar Remover is recommended.

## Window Cleaning

Use a window cleaning solution on very dirty or oil-stained windows.

## Wiper Blade

Clean the wiper blade rubber with a clean cloth and detergent solution. Replace blade twice a year; once before and once after winter.

## Headlamp Cleaning System

The condition of the wiper blades is important for satisfactory cleaning of the headlamp lenses. We therefore recommend that the blades be inspected regularly.

Replace damaged wiper blades.

## Seat Belts

The webbing must not be treated with chemical cleaning agents. Use only clear, lukewarm water and soap. Do not dry the webbing at temperatures above 176°F (80°C) or in direct sunlight.

## Warning!

**Do not bleach or dye seat belts as this may severely weaken them. In a crash they may not be able to provide adequate protection.**

## **Instrument Cluster**

Use a gentle dish-washing detergent or mild detergent for delicate fabrics as a washing solution. Wipe with a cloth moistened in lukewarm solution. Do not use scouring agents.

## **Steering Wheel and Gear Shift Lever**

Wipe with a damp cloth and dry thoroughly or clean with MB Leather Cleaner.

## **Upholstery**

Using aftermarket seat covers or wearing clothing that have the tendency to give off coloring (e.g. when wet etc.) may cause the upholstery to become permanently discolored. By lining the seats with a proper intermediate cover, contact-discoloration will be prevented.

Wipe leather upholstery with a damp cloth and dry thoroughly or clean with MB Leather Cleaner. Exercise particular care when cleaning perforated leather as its underside should not become wet.

## **Plastic Parts, Headliner and Rubber Parts**

Do not use oil or wax on these parts. See separate subjects for additional information.

## **Paintwork, Painted Body Components**

MB-Paint Protector and Sealer should be applied when water drops on the paint surface do not "bead up"; normally in 3 to 5 months depending on climate and washing detergent used.

MB-Paint-Polish should be applied if paint surface shows signs of dirt embedding (i.e. loss of gloss).

MB-Fine Polishing Paste must be used when the paint surface shows signs of excessive fading/ chalking due to lack of care etc..

Do not apply any of these products or wax if your car is parked in the sun or if the hood is still hot.

Use the appropriate MB-Touch-Up Stick for quick and provisional repairs of minor paint damage (i.e. chips from stones, car doors etc.).

## **Automatic Antenna**

For trouble-free operation of the automatic antenna, we recommend to clean the antenna mast periodically.

## **Light Alloy Wheels**

MB Autoshampoo should be used for regular cleaning of the light alloy wheels.

If possible, clean wheels once a week with MB-Autoshampoo, using a soft sponge and an ample supply of lukewarm water.

If the MB-Autoshampoo does not satisfactorily clean the wheels, use MB Protective Agent for Light Alloy Wheels for normal cleaning and MB-Cleaner for Light Alloy Wheels for heavier dirt accumulation.

Follow instructions on container.

## **Ornamental Moldings**

For regular cleaning and care of very dirty chrome-plated parts, use a chrome cleaner.

## **Soft Top**

Clean soft top with soft top raised and locked. Lower the soft top into the storage compartment only if the top is completely dry. If the top is kept in the storage compartment for a lengthy period, raise it and air it out with the windows down about every 4 months.

Dry cleaning:

Brush top (always from front to rear) with a soft-bristled brush.

Wet cleaning:

Brush the dry top. Wash with a mild detergent and an ample supply of lukewarm water by wiping with a soft-bristled brush or sponge from front to rear. Then rinse thoroughly with clear water.

If only parts of the top have been washed, wet the entire top and allow it to air-dry before lowering it into the storage compartment.

Wipe the rear window with a cloth soaked with a mild, non-abrasive detergent, rinse and rub dry.

Do not use sharp-edged instruments for the removal of ice and snow.

Note:

Never run the vehicle through an automatic car wash with the soft top in place as you may damage the soft top material.

Remove bird droppings immediately. The organic acid damages the material and causes the soft top to leak.

In general, regular spraying or cleansing with clear water is sufficient to keep the top clean.

Wash the top only when heavily soiled.

### **Caution!**

Never use any gasoline, thinner, tar and stain removers, glass cleaner, or similar organic solvents to clean the soft top, plastic window or wind screen. They will cause damage which is not covered by the Mercedes-Benz - Limited Warranty.

## **Wind Screen**

Use only water or mild detergent to clean the wind screen.

## **Hard Plastic Trim Items**

Pour MB Plastic Cleaner onto soft Lint-free cloth and apply with light pressure.

## **Headliner**

Soft top:  
Clean with soft bristle brush, or use a dry-shampoo cleaner in case of excessive dirt.

Hardtop:  
Pour MB Plastic Cleaner onto soft lint-free cloth and apply with light pressure.

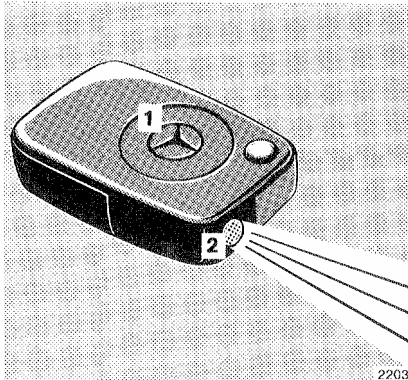

## Testing Infrared Remote Control

### Checking Batteries:

If the transmit button (1) is pressed longer than 1 second, the battery indicator lamp in the transmitter eye (2) briefly illuminates -indicating that the batteries are in order.

Change batteries if the indicator lamp does not come on.

### Changing Batteries:

Slide release (3) laterally and pull off battery cover (4).  
Change batteries

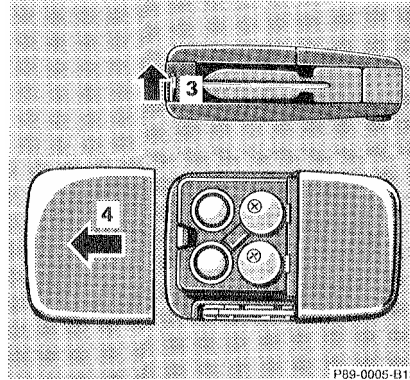

When inserting new batteries, make sure they are correctly installed.

Slide battery cover onto housing until locked in place.

### Important!

Batteries contain materials that can harm the environment if disposed of improperly. Recycling of batteries is the preferred method of disposal. For disposal, please follow manufacturer's recommendation on battery package.

Replacement battery:  
Silver oxide, type 76 or  
Mercury oxide, type 675

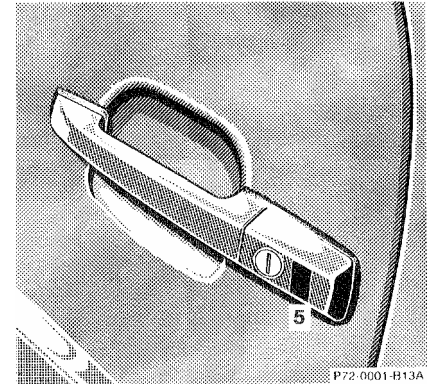

## Synchronizing System:

The system may have to be re-synchronized, if the transmitter is without voltage for several minutes.

To synchronize system, aim transmitter (2) at a receiver (5) and briefly press transmit button (1). Within approx. 30 seconds, lock or unlock the car at a door or the trunk using the master key.

The infrared remote control should once again be operational.

### Locking Soft Top Manually

In case of malfunction, the power soft top can also be raised manually. This procedure should be performed with great care by 2 persons.

A combination open-end/ Allen-head wrench in the vehicle tool kit is required for this job.

1. Open doors or lower windows.
2. Lower roll bar with roll bar switch. If the roll bar cannot be lowered, the soft top can be carefully guided over the roll bar.
3. For safety reasons from steering lock.

### Warning!

**Do not place your hands near the roll bar, soft top frame, upper windshield area or soft top storage compartment while the soft top is being locked. Serious personal injury may occur.**

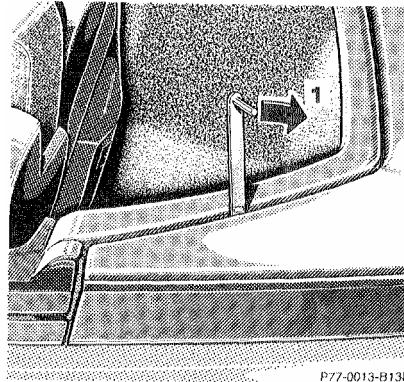

4. Unlock left and right soft top storage compartment locks: Place open-end wrench on bolt between roll bar and storage compartment cover. Turn wrench towards rear of car (1).

Open storage compartment cover and place in upright position (2).

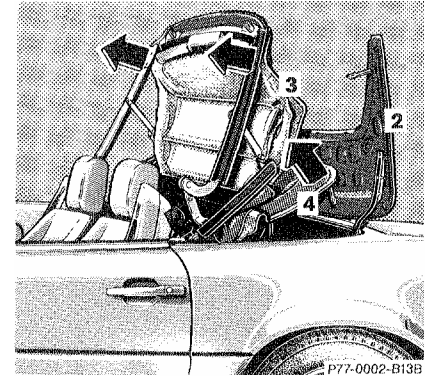

5. Pull soft top (3) together with soft top bow (4) out of compartment.

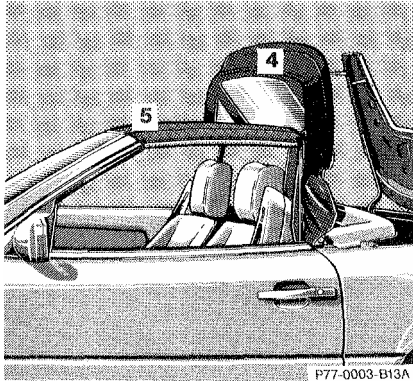

6. Place soft top bow (4) in vertical position and soft top frame (5) onto windshield header.

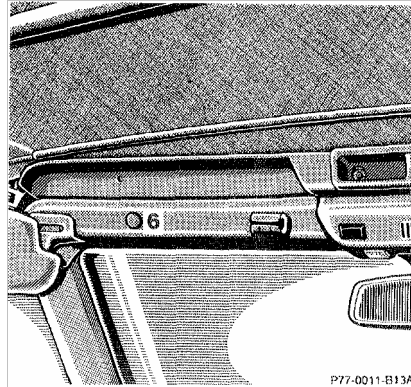

7. Pivot sun visors to side.  
Remove left and right caps (6).

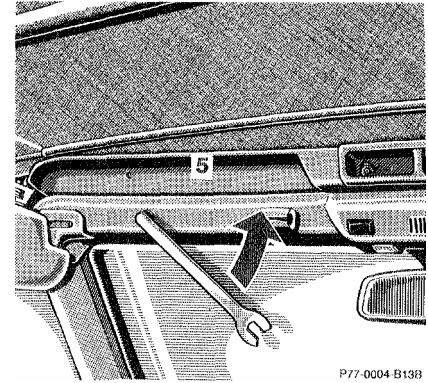

6. Using Allen-head wrench, lock left and right of soft top frame (5) to windshield header - turn wrench in 3 stages towards center of car:
  1. Left lock to first notch
  2. Right lock to second notch
  3. Left lock to second notch.

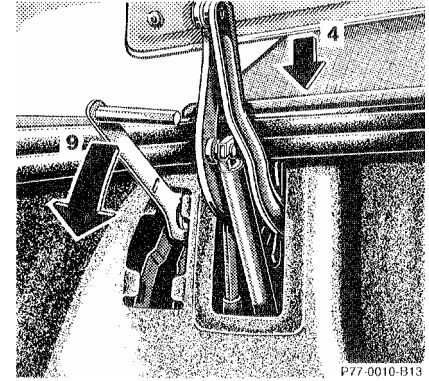
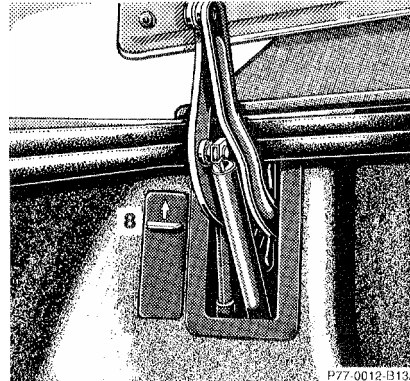
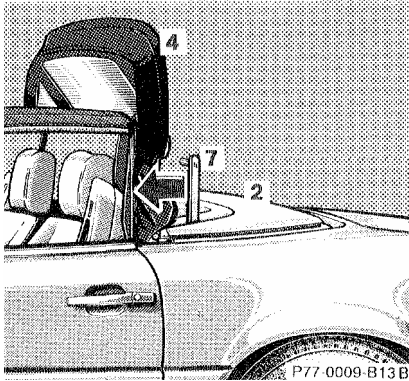

9. Close storage compartment cover (2). Lock left and right storage compartment locks: Place open-end wrench on bolt between roll bar and storage compartment cover. Turn wrench towards front of car (7).
10. Fold soft top bow (4) down and guide lock pins into locks.

11. Open left and right access covers (8) in trunk by pushing up and removing.

12. Place open-end wrench on lever marked in red. Press soft top bow (4) down and lock with open-end wrench in 3 stages.
  1. Left lock to first notch
  2. Flight lock to second notch
  3. Left lock to second notch.

Press the open-end wrench down (9) only until the lock audibly engages.

Have the power soft top chocked at your authorized MERCEDES-BENZ dealer as soon as possible.



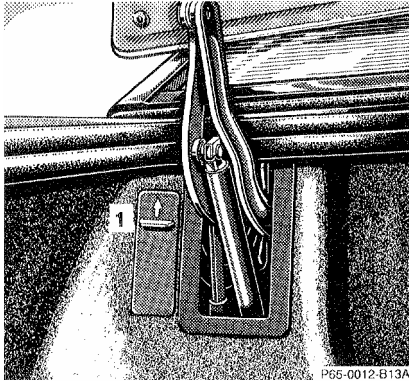

### Locking Hardtop Manually

In case of malfunction, the hardtop can also be locked manually.

A combination open-end/Allen-head wrench in the vehicle tool kit is required for this job.

1. Open left and right access covers (1) in the trunk by pushing up and removing.



2. Place open-end wrench on lever marked in red.

Push the hard top down (2) and using the open-end wrench, lock the hard top in the following sequence:

1. Left lock to first notch
2. Right lock to second notch
3. Left lock to second notch

Press the open-end wrench down (3) only until the lock audibly engages.

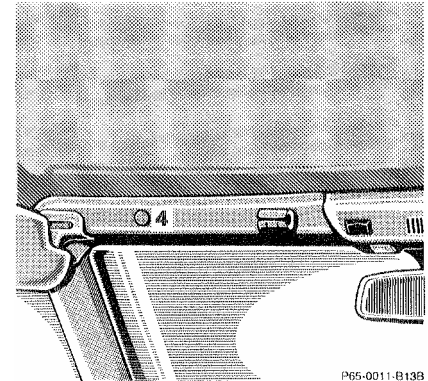

3. Pivot sun visors to side. Remove left and right caps (4).

### Warning!

**Do not place your hands between the hardtop and the body while the hardtop is being locked. Serious personal injury may occur.**

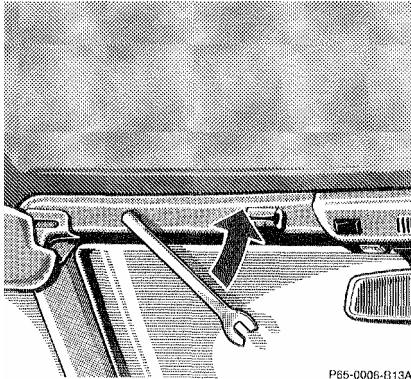

4. Using Allen-head wrench, lock left front and right front of hardtop to windshield header -turn wrench in 3 stages towards center of car:

1. Left lock to first notch
2. Right lock to second notch
3. Left lock to second notch.

Have the hardtop checked at your authorized MERCEDES-BENZ dealer as soon as possible.

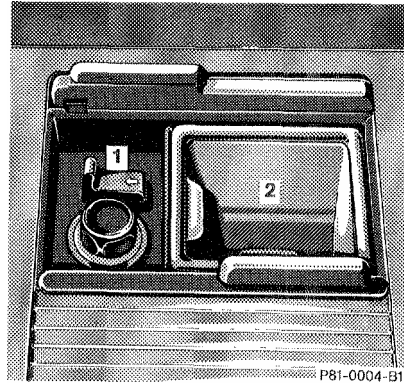

### Ashtray

#### Removal:

Slide open cover, push the sliding knob (1) to the left to eject the insert (2).

#### Installation:

Install insert into ashtray frame and push down to engage.

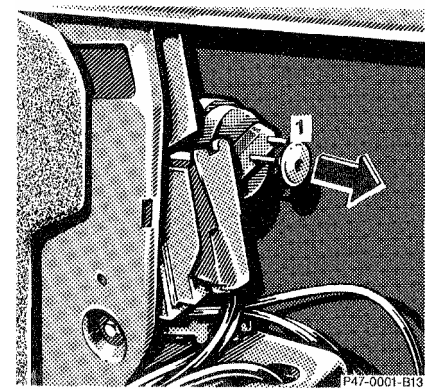

### Manual Release of Fuel Filler Flap

In case of malfunction, the fuel filler flap can be opened manually. Pull the manual release knob (1) behind the right trunk panel while simultaneously opening the fuel filler flap.

### Ski Rack

Use only our approved ski rack to avoid damage to the vehicle. Follow manufacturer's installation instructions.

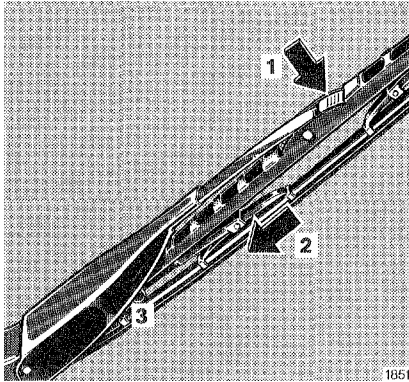

## Replacing Wiper Blades

For safety reasons, remove key from steering lock before replacing wiper blade, otherwise the motor can suddenly turn on and cause injury.

## Windshield Wiper Blade

**Removal:**  
Fold wiper arm forward. Press safety tab down (1), push wiper blade downward (2) and remove.

**Installation:**  
Press down safety tab of new wiper blade. Insert wiper blade between the tabs (3) on the wiper arm. Then press safety tab upward until it locks in place.

**Note:**  
Do not open engine hood with wiper arm folded forward.

Do not allow the wiper arm to contact the windshield glass without a wiper blade inserted. The glass may be scratched or broken.

Make certain that the wiper blade is properly installed. An improperly installed blade may cause windshield damage.

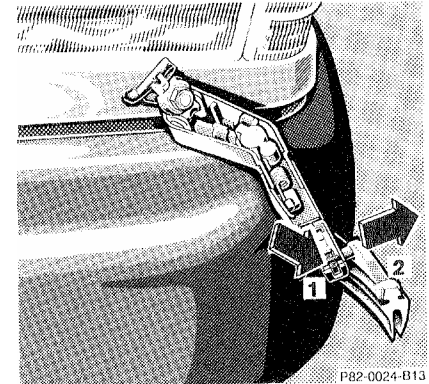

## Headlamp Wiper Blades

**Removal:**  
Fold wiper arm forward. Press safety tab (1) down and remove wiper blade at guide pin (2, arrow).

**Installation:**  
Press safety tab (1) down and insert the guide pin (2) into the wiper arm. Release safety tab, the wiper blade engages.

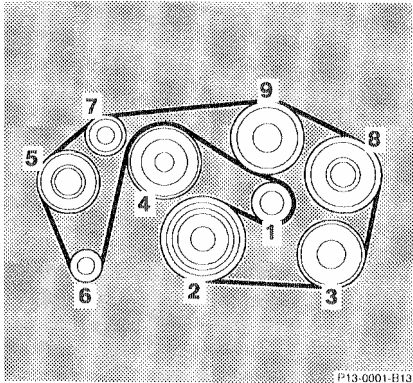

320 SL, 600 SL

#### Layout of Poly-V-Belt Drive

1. Automatic belt tensioner
2. Crankshaft
3. Air conditioning compressor
4. Fan
5. Air pump
6. Generator (alternator)

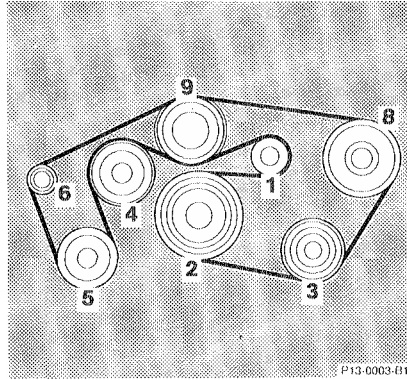

500 SL

7. Idler pulley
8. Power steering pump
9. Coolant pump

For dimensions of the poly-V-belt see *Technical Data* in Index.

#### Spare Parts Service

All authorized MERCEDES-BENZ dealers maintain a stock of original spare parts required for maintenance and repair work. In addition, strategically located parts distribution centers provide quick and reliable parts service,

More than 300,000 different spare parts, even for older models, are available.

MERCEDES-BENZ original spare parts are subjected to the most stringent quality inspections. Each part has been specifically developed, manufactured or selected for and adapted to MERCEDES-BENZ vehicles.

Therefore, MERCEDES-BENZ original spare parts should be installed.



## **Technical Data**

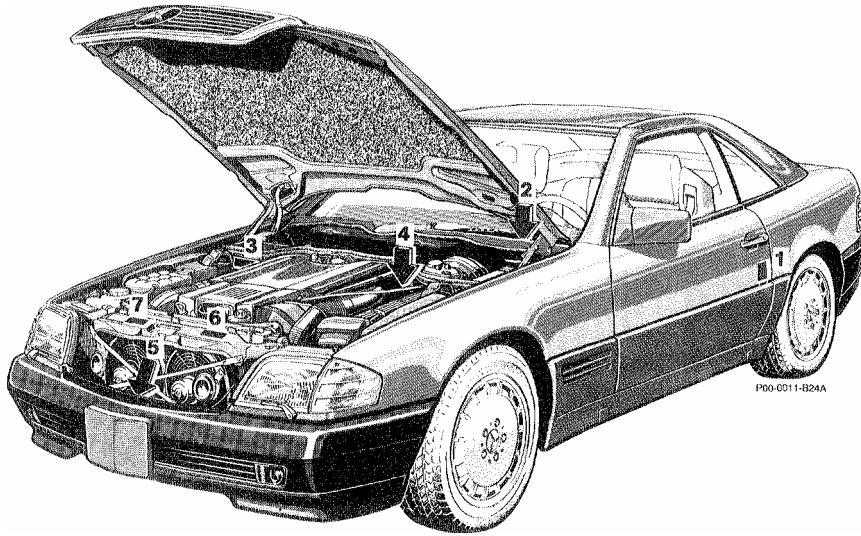

1. Certification Tag  
(left door pillar)
2. Identification Tag  
(left window post)
3. Vehicle Identification No.
4. Engine No.  
(320 SL right front,  
600 SL right rear)
5. Body No. and Paint No.
6. Emission Control Tag
7. Information Tag  
California version  
Vacuum line routing for  
emission control system

### Identification Plates

When ordering spare parts,  
please specify vehicle identification and engine numbers.

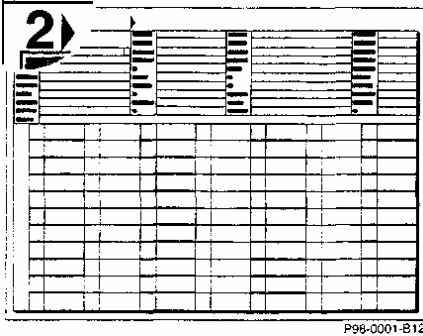

### Vehicle Data Card

The vehicle data card contains all important data pertaining to the vehicle. It should be kept in the maintenance booklet where indicated, and it is needed when obtaining replacement or additional keys at your authorized Mercedes-Benz dealer.

### Warranty Coverage

Your car is covered under the terms of the "warranties" printed in the Owner's Service and Warranty Policy Booklet and your authorized MERCEDES-BENZ dealer will exchange or repair any defective parts in accordance with the terms of the following warranties:

1. New vehicle limited warranty
2. Emission systems warranty
3. Emission performance warranty
4. California emission control systems warranty.

### Loss of Owner's Service and Warranty Policy

Should you lose your Owner's Service and Warranty Policy Booklet, have your authorized MERCEDES-BENZ dealer arrange for a replacement. It will be mailed to you.



## Technical Data SL 320

Model	SL 320 (129 061) <sup>1</sup>
<b>Engine</b>	104
Mode of operation	4-stroke engine, gasoline injection
No. of cylinders	6
Bore	89.90 mm (3.54 in)
Stroke	84.00 mm (3.30 in)
Total piston displacement	3199 cm <sup>3</sup> (195.2 cu.in)
Compression ratio	10
Output acc.to SAE J 1349	170 kW/5600rpm (228 hp/5600 rpm)
Maximum torque acc. to SAE J 1349	315 Nm/3750 rpm (232 ft-lb/3750 rpm)
Maximum engine speed	6700 rpm
Firing order	1-5-3-6-2-4
Poly – V belts length	2445 mm

<sup>1</sup> The quoted data apply only to the standard vehicle. See an authorized Mercedes-Benz dealer for the corresponding data of all special bodies and special equipment.

## Rims – Tires

Rims (light alloy rims)	8J x 16 H 2
Wheel offset	34 mm (1.3 in)
Summer tires:	
Radial-ply tires	225/55 ZR 16
Winter tires:	
Radial-ply tires	225/55 R 16 93 T M+S 225/55 R 16 93 H M+S
<b>Electrical System</b>	
Generator (alternator)	14 V/100A
Starter motor	12 V/1.7 kW
Battery	12 V/100 Ah
Spark plugs	Bosch F 9 DCO Beru 14 F-9 DUO Champion C 12 YCC
Electrode gap	0.8 mm (0.032 in)
Tightening torque	20-30 Nm (15–22 ft.lb)

## Technical Data SL 320

<b>Weights</b>	See certification tag
Hardtop load max.	30 kg (66 lb)
Trunk load max.	100 kg (220 lb)

<b>Main Dimensions</b>	
Overall vehicle length	4470 mm (176.0 in)
Overall vehicle width	1812 mm ( 71.3 in)
Overall height:	
Soft top	1298 mm ( 51.1 in)
Hardtop	1288 mm ( 50.7 in)
Wheel base	2515 mm ( 99.0 in)
Track, front	1535 mm ( 60.4 in)
Track, rear	1523 mm ( 60.0 in)

## Technical Data SL 500

Model	SL 500 (129 066) <sup>1</sup>
<b>Engine</b>	119
Mode of operation	4-stroke engine, gasoline injection
No. of cylinders	8
Bore	96.50 mm (3.80 in)
Stroke	85.00 mm (3.35 in)
Total piston displacement	4973 m <sup>3</sup> (305.5 cu.in)
Compression ratio	10
Output acc.to SAE J 1349	235 kW/5600rpm (315 hp/5600 rpm)
Maximum torque acc. to SAE J 1349	470 Nm/3900 rpm (347 ft-lb/3900 rpm)
Maximum engine speed	6000 rpm
Firing order	1-5-4-8-6-3-7-2
Poly – V - belts length	2523mm

## Transmission

Downshift points,	D to 3: 189 km/h (117 mph)
	3 to 2: 121 km/h (75 mph)
	2 to B: 71 km/h (44 mph)

## Rims – Tires

Rims (light alloy rims)	8J x 16 H 2
Wheel offset	34 mm (1.3 in)
Summer tires:	
Radial-ply tires	225/55 ZR 16
Winter tires:	
Radial-ply tires	225/55 R 16 93 T M+S 225/55 R 16 93 H M+S

## Electrical System

Generator (alternator)	14 V/100A
Starter motor	12 V/1.7 kW
Battery	12 V/100 Ah
Spark plugs	Bosch F 9 DCO Beru 14 F-9 DUO Champion C 12 YCC
Electrode gap	0.8 mm (0.032 in)

<sup>1</sup> The quoted data apply only to the standard vehicle. See an authorized Mercedes-Benz dealer for the corresponding data of all special bodies and special equipment.

## Technical Data SL 500

<b>Weights</b>	See certification tag
Hardtop load max.	30 kg ( 66 lb)
Trunk load max.	100 kg (220 lb)

<b>Main Dimensions</b>	
Overall vehicle length	4470 mm (176.0 in)
Overall vehicle width	1812 mm ( 71.3 in)
Overall height:	
Soft top	1298 mm ( 51.1 in)
Hardtop	1288 mm ( 50.7 in)
Wheel base	2515 mm ( 99.0 in)
Track, front	1532 mm ( 60.4 in)
Track, rear	1521 mm ( 60.0 in)

## Technical Data SL 600

Model	SL 600 (129 076) <sup>1</sup>
<b>Engine</b>	120
Mode of operation	4-stroke engine, gasoline injection
No. of cylinders	12
Bore	89.00 mm (3.50 in)
Stroke	80.20 mm (3.16 in)
Total piston displacement	5987 m <sup>3</sup> (365.4 cu.in)
Compression ratio	10:1
Output acc.to SAE J 1349	290 kW/5200rpm (389 hp/5200 rpm)
Maximum torque acc. to SAE J 1349	570 Nm/3800 rpm (421 ft-lb/3800 rpm)
Maximum engine speed	6000 rpm
Firing order	1-12-5-8-3-10-6-7-2- 11-4-9
Poly – V - belts length	2585mm

## Transmission

Downshift points	D to 3: 189 km/h (117 mph)
	3 to 3: 121 km/h (75 mph)
	2 to B: 71 km/h (44 mph)

## Rims – Tires

Rims (light alloy rims)	8J x 16 H 2
Wheel offset	34 mm (1.3 in)
Summer tires:	
Radial-ply tires	225/55 ZR 16
Winter tires:	
Radial-ply tires	225/55 R 16 93 T M+S 225/55 R 16 93 H M+S

## Electrical System

Alternator	14 V/110A
Starter motor	12 V/2.2 kW
Battery	12 V/100 Ah
Spark plugs	Bosch F 9 DCO Beru 14 F-9 DUO Champion C 12 YCC
Electrode gap	0.8 mm (0.032 in)
Tightening torque	20-30 Nm (15–22 ft.lb)

<sup>1</sup> The quoted data apply only to the standard vehicle. See an authorized Mercedes-Benz dealer for the corresponding data of all special bodies and special equipment.

## Technical Data SL 600

### Weights

See certification tag

Hardtop load max.	30 kg ( 66 lb)
Trunk load max.	100 kg (220 lb)

### Main Dimensions

Overall vehicle length	4520 mm (178.0 in)
Overall vehicle width	1812 mm ( 71.3 in)
Overall height:	
Soft top	1303 mm ( 51.3 in)
Hardtop	1293 mm ( 50.9 in)
Wheel base	2515 mm ( 99.0 in)
Track, front	1535 mm ( 60.4 in)
Track, rear	1523 mm ( 60.0 in)

## Fuels , Coolants, Lubricants etc. - Capacities

Vehicle components and their respective lubricants must match.

Therefore use only brands tested and recommended by us.

Inquire at your authorized Mercedes-Benz dealer.

	Model	Capacity	Fuels, coolants, lubricants etc.
Engine with oil filter	SL 320	7.5 l (7.9 US qt)	Recommended engine oils
	SL 500	8.0 l (8.5 US qt)	
	SL 600	11.0 l (11.6 US qt)	
Automatic transmission	SL 320	Initial fill: 7.1 l (7.5 US qt) Fluid change: 6.0l US qt 6.3	Automatic transmission fluid
	SL 500	Initial fill: 8.6 l (9.1 US qt)	
	SL 600	Fluid change: 7.7l US qt 8.1	
Rear axle		1.3 l (1.4 US qt)	Hypoid gear oil SAE 90, SAE 85 W 90 <sup>1</sup>
Hydraulic system for Adaptive damping System (ADS)		approx. 4.5 l (4.8 US qt)	MB Hydraulic fluid
Power steering		approx. 1.0 l (1.1 US qt)	MB Power steering fluid <sup>1</sup>
Front wheel hubs		approx. 60g (2.1 oz) each	High temperature roller bearing grease

	Model	Capacity	Fuels, coolants, lubricants etc.
Accelerator control linkage			Hydraulic fluid
Brake system		approx. 0.5 US qt (0.5 l)	MB Brake fluid (DOT 4)
Windshield washer and headlamp cleaning system		approx. 5.3 US qt (5.0 l)	MB Windshield washer concentrate "S" <sup>1</sup>
Cooling system	SL 320	approx. 12.2 US qt (11.5 l)	MB Anticorrosion/antifreeze
	SL 500	approx. 16.4 US qt (15.5 l)	
	SL 500	approx. 16.4 US qt (15.5 l)	
Fuel tank including a reserve of		approx. 21.1 US gal (80 l)	Premium unleaded gasoline: Posted Octane 91 (Average of 96 RON/86 MON)
		approx. 2.6 US gal (10 l)	
Air conditioner system			R-134a refrigerant and special lubricant ( <i>Never R-12</i> ) (selected vehicles - see underhood label)

<sup>1</sup> Use MB Windshield Washer Concentrate "S" and water for temperatures above freezing or MB Windshield Washer Concentrate "S" and commercially available premixed windshield washer solvent/antifreeze for temperatures below freezing. Follow suggested mixing ratios, see *Windshield/Headlamp Washer System* in Index.



## Engine Oils

Engine oils are specifically tested for their suitability in our engines. Therefore, use only engine oils recommended by Mercedes-Benz. Information on recommended brands is available at your authorized Mercedes-Benz dealer.

## Engine Oil Additives

Do not blend oil additives with engine oil. They may be harmful to the engine operation.

Damage or malfunctions resulting from blending oil additives are not covered by the Mercedes-Benz Limited Warranty.

## Air Conditioner Refrigerant

Ozone-friendly HFC-134a refrigerant and special lubricating oil is used in the air conditioner system. Never use R-12 (CFG) or mineral-based lubricating oil, otherwise damage to the system will occur.

## Brake Fluid

During vehicle operation, the boiling point of the brake fluid is continuously reduced through the absorption of moisture from the atmosphere. Under extremely hard operating conditions, this moisture content can lead to the formation of bubbles in the system thus reducing the system's efficiency.

The brake fluid must therefore be replaced every two years, preferably in the spring.

It is recommended to use only brake fluid approved by Mercedes Benz. Your authorized Mercedes-Benz dealer will provide you with additional information.

## Premium Unleaded Gasoline

### Caution!

To maintain the engine's durability and performance, premium unleaded gasoline must be used. If premium unleaded is not available and low octane fuel is used, follow these precautions:

- have the fuel tank filled only partially with unleaded regular and fill up with premium unleaded as soon as possible,
- avoid full throttle driving and abrupt acceleration,
- do not exceed an engine speed of 3000 rpm, if the vehicle is loaded with a light load such as two persons and no luggage,
- do not exceed  $\frac{2}{3}$  of maximum accelerator pedal position, if the vehicle is fully loaded or operating in mountainous terrain.

## **Fuel Requirements**

Use only Premium unleaded meeting ASTM standard D 439:

The octane number (posted at the pump) must be 91min. It is an average of both, the Research (R) octane number and the Motor (M) octane number:  $[(R + M)/2]$ . This is also known as ANTI-KNOCK INDEX.

Unleaded gasoline containing oxygenates such as Ethanol, IPA, IBA and TBA can be used provided the ratio of any one of these oxygenates to gasoline does not exceed 10%, MTBE not to exceed 15%.

The ratio of Methanol to gasoline must not exceed 3% plus additional cosolvents.

Using mixtures of Ethanol and Methanol is not allowed. Gasohol, which contains 10% Ethanol and 90% unleaded gasoline, can be used.

These blends must also meet all other fuel requirements such as resistance to spark knock, boiling range, vapor pressure etc..

## **Gasoline Additives**

A major concern among engine manufacturers is carbon build up caused by gasoline. Mercedes-Benz recommends to use only quality gasoline containing additives that prevent the build up of carbon deposits.

After an extended period of using fuels without such additives, carbon deposits can build up especially on the intake valves and in the combustion area, leading to engine performance problems such as:

- warm-up hesitation,
- unstable idle,
- knocking/pinging,
- misfire,
- power loss.

Damages or malfunctions resulting from poor fuel quality are not covered by the Mercedes-Benz Limited Warranty.

## Coolants

The engine coolant is a mixture of water and anticorrosion/anti-freeze, which provides:

- corrosion protection
- freeze protection
- boiling protection (by increasing the boiling point).

The cooling system was filled at the factory with a coolant providing freeze protection to approx. -22 °F (-30 °C) and corrosion protection.

The coolant solution must be used year round to provide the necessary corrosion protection and increase in the boil-over protection. You should have it replaced every 3 years.

To provide the important corrosion protection, the solution must be at least 45% anticorrosion/antifreeze (equals a freeze protection to approx. -22 °F [-30 °C]). If you use a solution that is more than 55% anticorrosion/antifreeze (freeze protection to approx. -49 °F [-45°C]), the engine temperature will increase due to the lower heat transfer capability of the solution.

Therefore, do not use more than this amount of anti-corrosion/antifreeze. If the coolant level is low, water and MB anticorrosion/antifreeze should be used to bring it up to the proper level (have cooling system checked for signs of leakage).

The water in the cooling system must meet minimum requirements, which are usually satisfied by normal drinking water. If you are not sure about the water quality, consult your authorized Mercedes-Benz dealer.

### Anticorrosion/antifreeze

Your vehicle contains a number of aluminum parts. The use of aluminum components in motor vehicle engines necessitates that anticorrosion/antifreeze coolant used in such engines be specifically formulated to protect the aluminum parts. (Failure to use such anticorrosion/antifreeze coolant will result in a significantly shortened service life.)

Therefore the following product is strongly recommended for use in your car: Mercedes-Benz Anticorrosion/Antifreeze Agent.

Before the start of the winter season (or once a year in the hot southern regions), you should have the anticorrosion/antifreeze concentration checked. The coolant is also regularly checked each time you bring your vehicle to your authorized Mercedes-Benz dealer for maintenance service.

Anticorrosion/antifreeze quantity

## Consumer Information

This has been prepared as required of all manufacturers of passenger cars under Title 49, Code of U.S. Federal Regulations, Part 575 pursuant to the "National Traffic and Motor Vehicle Safety Act of 1966".

## Uniform Tire Quality Grading

Refer to the tire sidewall for the specific tire grades for the tires with which this vehicle is equipped.  
All passenger car tires must conform to federal safety requirements in addition to these grades.

### Treadwear

The treadwear grade is a comparative rating based on the wear rate of the tire when tested under controlled conditions on a specified government test course. For example, a tire graded 150 would wear one and one-half ( $1\frac{1}{2}$ ) times as well on the government course as a tire graded 100. The relative performance of tires "depends upon the actual conditions of their use, however,

and may depart significantly from the norm due to variations in driving habits, service practices and differences in road characteristics and climate.

### Traction "A", "B", "C"

The traction grades, from highest to lowest, are "A", "B" and "C" and they represent the tire's ability to stop on wet pavement as measured under controlled conditions on specified government test surfaces of asphalt and concrete. A tire marked "C" may have poor traction performance.

### Warning!

**The traction grade assigned to this tire is based on braking (straight ahead) traction tests and does not include cornering (turning) traction.**

### Temperature "A", "B", "C"

The temperature grades are "A" (the highest), "B" and "C", representing the tire's resistance to the generation of heat and its ability to dissipate heat when

tested under controlled conditions on a specified indoor laboratory test wheel. Sustained high temperature can cause the material of the tire to degenerate and reduce tire life, and excessive temperature can lead to sudden tire failure. The grade "C" corresponds to a level of performance which all passenger car tires must meet under the Federal Motor Vehicle Safety Standard No. 109. Grades "B" and "A" represent higher levels of performance on the laboratory test wheel than the minimum required by law.

### Warning!

**The temperature grade for this tire is established for a tire that is properly inflated and not overloaded. Excessive speed, underinflation, or excessive loading, either separately or in combination, can cause excessive heat build up and possible tire failure.**

## **Problems with your Vehicle**

If you should experience a problem with your vehicle, particularly one that you believe may affect its safe operation, we urge you to immediately contact your authorized Mercedes-Benz dealer to have the problem diagnosed and corrected if required. If the matter is not handled to your satisfaction, please discuss the problem with the dealership management, or if necessary contact the Owner Service Manager at the Mercedes-Benz Regional Office nearest you (see Owner's Service and Warranty Information booklet for addresses). You may also write directly to us at the following addresses:

In the U.S.A.:           Owner Service Department  
Mercedes-Benz of North America Inc.  
One Mercedes Drive  
Montvale, NJ 07645-0350

In Canada:             Owner Service Department  
Mercedes-Benz Canada Inc.  
849 Eglinton Avenue East  
Toronto, Ontario, M4G 2L5

For the U.S.A. only.

The following text is published as required of manufacturers under Title 49, Code of U.S. Federal Regulations, Part 575 pursuant to the "National Traffic and Motor Vehicle Safety Act of 1966".

### **Reporting Safety Defects**

If you believe that your vehicle has a defect which could cause a crash or could cause injury or death, you should immediately inform the National Highway Traffic Safety Administration (NHTSA) in addition to notifying Mercedes-Benz of North America Inc..

If NHTSA receives similar complaints, it may open an investigation, and if it finds that a safety defect exists in a group of vehicles, it may order a recall and remedy campaign. However, NHTSA cannot become involved in individual problems between you, your dealer, or Mercedes-Benz of North America Inc..

To contact NHTSA, you may either call the Auto Safety Hotline toll-free at 1-800-424-9393 (or 366-0123 in Washington, D.C. area) or write to: NHTSA, U.S. Department of Transportation, Washington, D.C. 20590. You can also obtain other information about motor vehicle safety from the Hotline.



## **Index**



ABS [77](#), [79](#), [88](#)  
Acceleration slip control (ASR) [89](#)  
Adaptive damping system (ADS)[91](#)  
ADS [91](#), [136](#)  
Air conditioner refrigerant [138](#)  
Airbag [45](#)  
Alarm system [33](#)  
Antenna [64-65](#), [72](#), [116](#)  
Anti-theft alarm system [33](#)  
Anticorrosion/antifreeze [93](#), [97](#),[137](#),[140](#)  
Antilock brake system (ABS) [88](#)  
Armrest [39](#)  
Ashtray [123](#)  
ASR [87](#), [89](#), [93](#)  
Automatic climate control [22](#)  
Automatic transmission [75](#)  
Automatic transmission fluid level,  
checking [99](#)

Battery [107](#)  
Battery not being charged  
Charge indicator lamp [15](#),[82](#)  
Brake fluid [17](#),[87](#),[114](#),[137-138](#)  
Brake pads worn Brake pad wear  
indicator lamp87  
Brake warning lamp  
Brake fluid low [87](#)  
Brake warning lamp test [87](#)  
Brakes [16](#),[18](#),[74](#),[76-79](#),[81](#),[89](#)

Capacities: Fuels, coolants, lubricants  
etc. [136](#)  
Catalytic converter [14](#)  
Cellular telephone [72](#)  
Central locking system [29](#)  
Check regularly and before  
a long trip [152](#)  
Child restraint [43](#), [47](#), [49](#)  
Cleaning and care of the vehicle [114](#)  
Clock, setting [56](#)  
Combination switch [52](#)  
Consumer information [141](#)  
Coolant level low Adding  
coolant [97](#)  
Low engine coolant level  
warning lamp [85](#)  
Coolant level, checking [97](#)  
Coolant temperature gauge [84-85](#)  
Coolants [140](#)  
Cruise control [80](#)

Display Illumination [55](#)  
Drinking and driving [74](#)  
Driving instructions [16](#)  
Driving off [74](#)

Emergency tensioning  
retractor(ETR) [44](#)  
Emission control [92](#)  
Engine malfunction "CHECK ENGINE"  
malfunction indicator lamp [92](#)  
Engine oil consumption [83](#)  
Engine oil level low  
Low engine oil level warning lamp [98](#)  
Engine oil level, checking [98](#)  
Engine oil pressure gauge [15](#), [82](#)  
Engine oils [136](#), [138](#)  
Engine speed limit Overrevving [77](#), [79](#)  
Exterior lamp failure indicator lamp [86](#)  
Exterior lamp switch [51](#)

First aid kit [100](#)  
Fuel  
Fuel requirements [139](#)  
Gasoline additives [138](#) - [139](#)  
Premium unleaded gasoline  
[14](#), [137-138](#)  
Fuel consumption gauge [83](#)  
Fuel filler flap, manual release [123](#)  
Fuel reserve warning lamp [84](#)  
Fuses [108](#)

Hardtop [63](#), [122](#)  
Headlights [51](#)  
Heated seats [38](#)  
Hood [96](#)

Identification plates [128](#)  
Indicator lamp symbols [13](#)  
Instrument cluster [12](#)  
Interior central locking system [32](#)  
Interior lighting [59](#)

Jump starting [111](#)

Keys, vehicle [26](#)

Lamps, exterior  
Fog lamps [51](#)  
Headlamps [51](#), [86](#), [109](#)  
High mounted stop lamp [86](#)  
License plate lamp [51](#), [111](#)  
Taillamps [51](#), [110](#), [115](#)  
Layout of poly-V-belt drive [125](#)  
Lighter [58](#)  
Low engine oil Level warning lamp [83](#)

Maintenance [4](#), [8](#)

Memory [35](#)

Mirrors, adjusting [55](#)

Orthopedic seat backrest [37](#)

Outside temperature indicator [84](#)

Parking brake [15-18](#), [63](#), [65](#), [67-68](#),  
[74-79](#), [90](#), [87](#), [89](#), [99](#), [101](#), [103](#), [111](#)

Power seats [34](#)

Power windows [61](#)

Problems with your vehicle [142](#)

Rear view mirrors

Exterior rear view mirrors [54](#)

Inside rear view mirror [54-55](#), [59](#)

Rear window defroster [60](#)

Remote control, infrared [27](#), [118](#)

Replacing bulbs [109](#)

Roadside assistance [5](#)

Roll bar [61](#)

Roll bar warning lamp [86](#)

Safety guidelines for the seat belt,  
emergency tensioning retractor and  
airbag [48](#)

Seat belt and backrest lock warning  
lamp [86](#)

Seat belts and warning system [40](#)

Ski rack [123](#)

Sliding roof

Emergency operation [32](#)

Snow chains [90](#), [93](#)

Soft top [67](#), [117](#), [119](#)

Spare parts service [125](#)

Spare wheel [100](#)

SRS malfunction [45](#)

Starting and turning off the engine  
[15](#)

Steering column, adjusting [39](#)

Steering lock [50](#)

Storage compartments [57](#)

Sun visors [56](#)

Supplemental restraint system (SRS)  
[40](#), [44](#)

Tachometer [74](#)

Technical data [130](#)

Tire inflation pressure [106](#)

Tires [17-18](#), [89](#), [93](#), [101-102](#), [106](#),  
[130](#), [132](#), [134](#), [141](#)

Towing the vehicle [113](#)

Trip odometer [55](#)

Trunk lamp [100](#)

Trunk, separate locking and unlocking  
[30](#)

Turn signals [52-53](#), [113](#)

Vanity mirror [56](#)

Vehicle data card [129](#)

Vehicle jack [101](#)

Vehicle tools [101](#)

Warranty coverage [129](#)

Washing the car [115](#)

Wheels

Alloy wheels [116](#)

Rims and tires [101-102](#)

Wheels, changing [103](#)

Wind screen [70](#), [117](#)

Windshield/headlamp washer system

Fluid level low [85](#)

Washer fluid mixing ratio [53](#)

Winter driving [93](#)

Winter driving instructions [19](#)

Wiper blades, replacing [124](#)

## **Service and Literature**

Your authorized Mercedes-Benz dealer has trained technicians and original Mercedes-Benz parts to service your vehicle properly. For expert advice and quality service, see your authorized Mercedes-Benz dealer. If you are interested in obtaining service literature for your vehicle please contact your authorized Mercedes-Benz, dealer.  
We consider this to be the best way to obtain accurate information for your vehicle.

## **Warning!**

**To help avoid personal injury, be extremely careful when performing any maintenance work or repairs, improper or incomplete service may damage the vehicle or its equipment, which may in turn result in personal injury.**  
**If you have any question about carrying out some service, turn to the advice of an authorized Mercedes-Benz dealer.**





## Check Regularly and Before a Long Trip

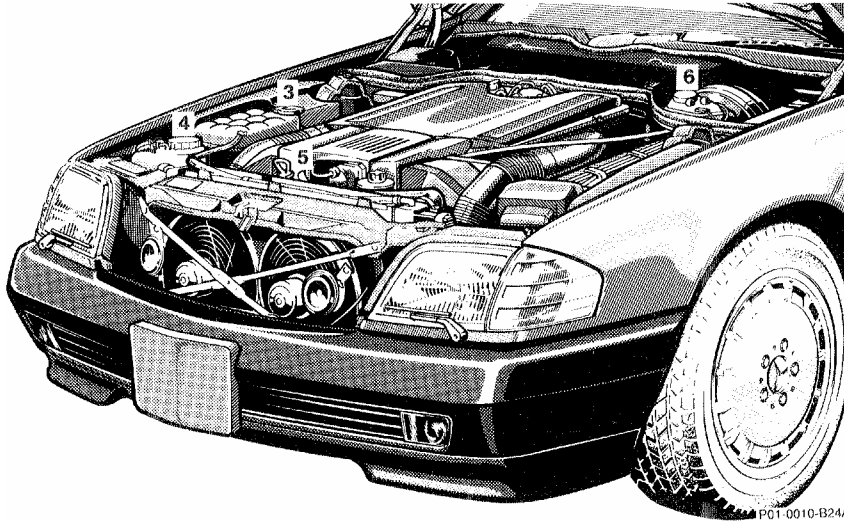
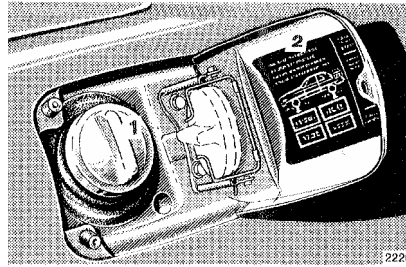
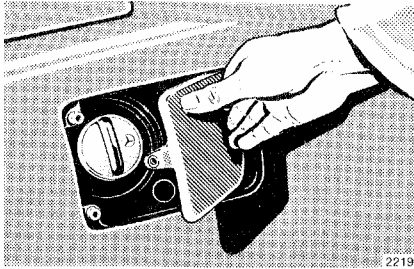

The engine compartment of model 500 SL is illustrated.

1. **Fuel Supply:** Turn fuel filler cap to the left and hold on to it until possible pressure in tank has been released, then remove cap.
2. **Tire Inflation Pressure:** Check at least every two weeks. For details see Index.
3. **Coolant Level:** See Index.
4. **Windshield Washer System, Headlamp Cleaning System:** See Index.
5. **Engine Oil Level:** See Index.
6. **Brake Fluid:** See Index.

**Vehicle Lighting:** Check function and cleanliness. For replacement of light bulbs, see Index.

## What You Should Know at the Gas Station

- **Fuel:**  
Use premium unleaded gasoline: Posted Octane index 91 (Average of 96 RON/86 MON).  
Fuel tank capacity approx. 21.1 US gal (80 l). This includes approx. 2.6 US gal (10 l) reserve.  
Only fill fuel tank until the filler nozzle unit cuts out - do not overfill.

### Warning!

**Gasoline vapor is highly flammable. It burns violently and can cause serious injury. Whenever you are around gasoline, extinguish all smoking materials. Never get sparks, flame or smoking materials near gasoline!**

- **Engine Oil:**  
Engine oil level check, see Index.  
Quantity differential between upper and lower dipstick marking level: 2.1 US qt (2.0 l).  
Recommended engine oils, see Index.
- **Automatic Transmission:**  
Automatic transmission fluid. For level checks refer to Index.

- **Coolant:**  
For normal replenishing, use water (potable water quality).  
For further information (e.g. anticorrosion/antifreeze), refer to Index.
- **Spark Plugs:**  
Approved spark plugs, refer to "Technical Data" (also see Index).
- **Bulbs:**  
High and low beams: Halogen type 9004,  
fog lamps: Halogen type H 1 (55 W),  
tail, parking, standing and driver's side  
rear fog lamp 21/4 W/ 35/ 1.2 cp,  
turn signal, standing, side marker and parking  
lamps, front 21/5 W/ 32P/3 cp,  
turn signal lamps, rear 21W/ 32 cp,  
stop lamps 21 W/ 32 cp,  
license plate lamps 5 W.
- **Tire Pressure:**  
For tire pressure, refer to tire pressure inside the fuel filler flap.
- **Air Conditioner:**  
R-134a refrigerant and special lubricant  
(in selected vehicles - see underhood label),  
refer to "Technical Data" (also see Index).